

Crestron Flex Medium Room Upgrade Solution with Zoom Rooms™ Software

The UC-M50-Z-UPGRD solution provides all of the necessary components to upgrade a deployed Crestron Flex tabletop conference device to a complete video conference system for use with Zoom Rooms™ software. It supports single or dual video displays and features a UC bracket assembly, cables, and power supplies.

Minimum Requirements:

- A Crestron Flex tabletop conference device ([CCS-UC-1 W/PS](#), [CCS-UC-1-AV W/PS](#), or [CCS-UC-1-AV-PLUS](#)) and camera
- A video display connected to the UC Engine. A second display is optional.
- A Zoom Rooms account or activation code



In the Box

UC Bracket Assembly

- 1 UC Bracket Assembly with UC Engine and HDMI® content ingest (UC-BRKT-200-S-Z-ASSY, 6511479)
- 2 Anchor, Drywall, Plastic, 3/8 in. x 1/2 in. (9.5 mm x 12.7 mm) (2052565)
- 2 EDID passthrough (2055728)
- 1 Key, Anchor (4529654)
- 2 Screw, 8-AB x 1-1/2 in. (38.1 mm), Pan Head, Combo (2052567)
- 4 Tie Wrap (2047935)

Additional Items

- 1 Cable, CAT5e, RJ-45 - RJ-45, 7 ft (2.1 m) (6509924)
- 1 Cable, DisplayPort™ to HDMI, 6 ft (1.8 m) (6508282)
- 1 Cable, HDMI, 20 ft (6.1 m) (6503567)

- 1 Cable, HDMI, 6 ft (1.8 m) (6503565)
- 1 Cable, USB Extension, USB Type A Male-to-Female, 15 ft (4.6 m) (6508260)



Configure the Conference Device

Prior to making system connections, deployed conference devices must be configured to operate as part of a complete Zoom Rooms system. Some deployed conference devices may be operating in Crestron Default mode. Ensure that the conference device operates in Zoom Rooms mode, and update the Zoom Rooms controller software as described below.

To configure the conference device:

1. On a computer, open a web browser to the IP address displayed on the conference device.

NOTES:

- The device and computer must be on the same network switch and VLAN.
 - A login with administrative rights for the device is required.
2. Log in to the device and navigate to **DEVICE > Applications**.
 3. From the **Application Mode** drop down menu, select **Zoom Rooms**.
 4. Click **Save Changes**. The conference device will reboot in Zoom Rooms mode and log out all users.
 5. Log in to the device and navigate to **DEVICE > Device Management**.
 6. In the **Maintenance** section, select **Restore** to reset the device to the factory default settings. All users are logged out of the device.
 7. Log in to the device and navigate to **DEVICE > Applications**.

Crestron Flex Medium Room Upgrade Solution with Zoom Rooms™ Software

8. From the **Application Upgrade** menu, select **Update Now** to update the Zoom Rooms controller software.

For system configuration, refer to [Configure](#).



Mount Devices

Mount the UC Bracket Assembly to VESA® compliant display devices, a wall, or other building structure. Anchors and screws are supplied for installation on walls 3/8 in. (9.5 mm) to 3/4 in. (19 mm) thickness.

CAUTION: Preinstalled screws may protrude from the back of the UC Bracket Assembly. Exercise caution when handling the UC Bracket Assembly to avoid scratching or damaging surfaces.

NOTE: The integrated cable tie wraps are reusable. Avoid damaging the cable tie wraps.

Crestron Flex Medium Room Upgrade Solution with Zoom Rooms™ Software



Connect

System Overview

When connections are complete, the system appears as shown below. Refer to [Make Connections](#) for detailed connection instructions.

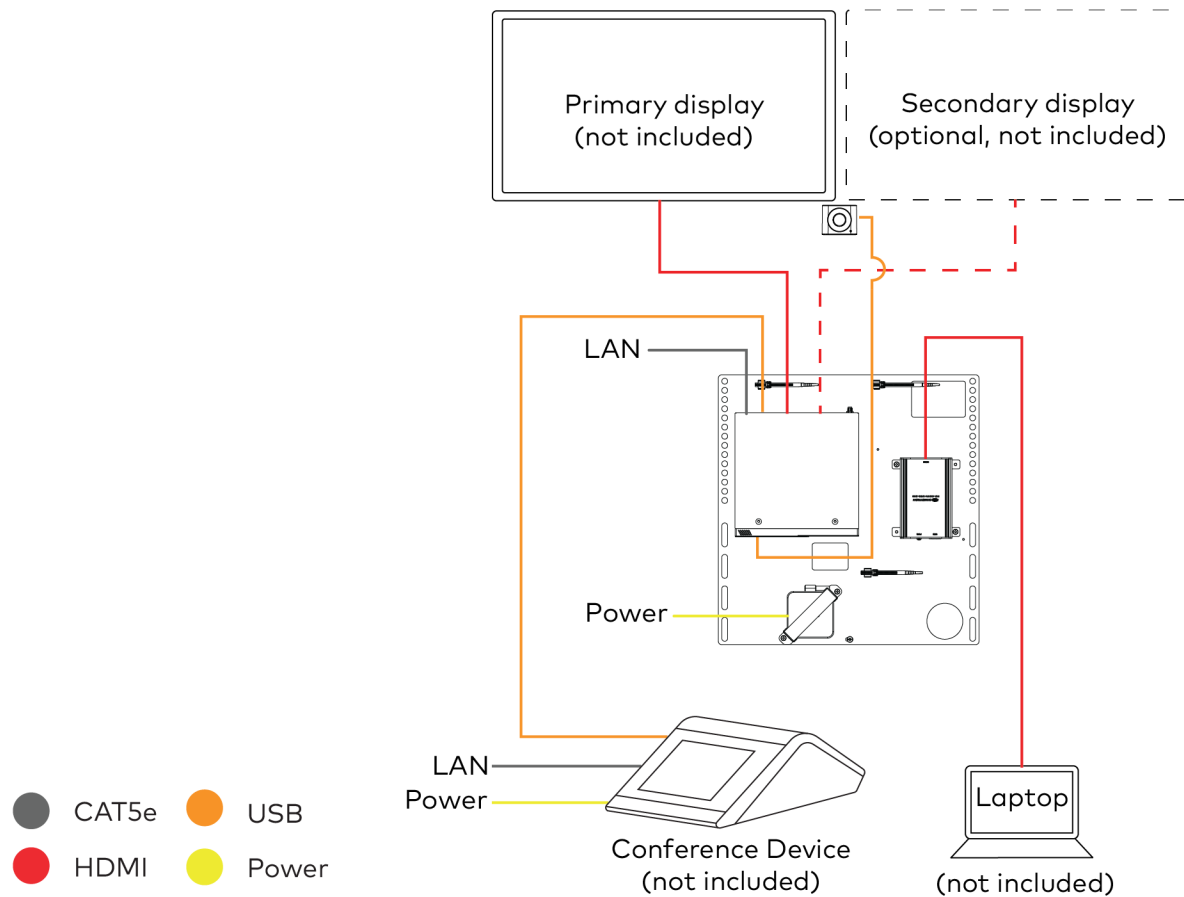

Crestron Flex Medium Room Upgrade Solution with Zoom Rooms™ Software

Make Connections

1. Make UC Engine connections as shown in the following illustration.

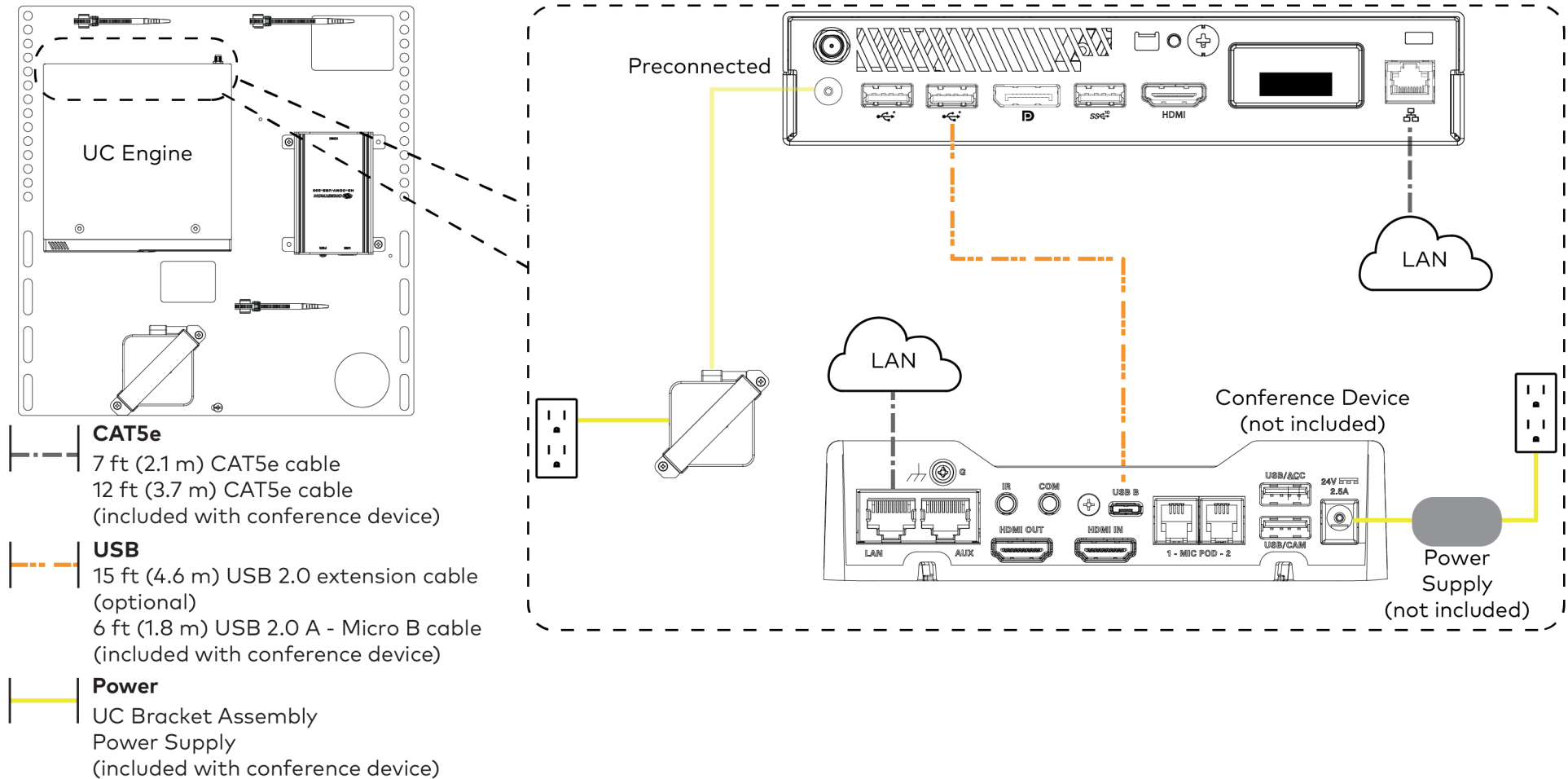

Crestron Flex Medium Room Upgrade Solution with Zoom Rooms™ Software

2. Connect displays to the UC Engine. Connect the EDID passthroughs to the displays.

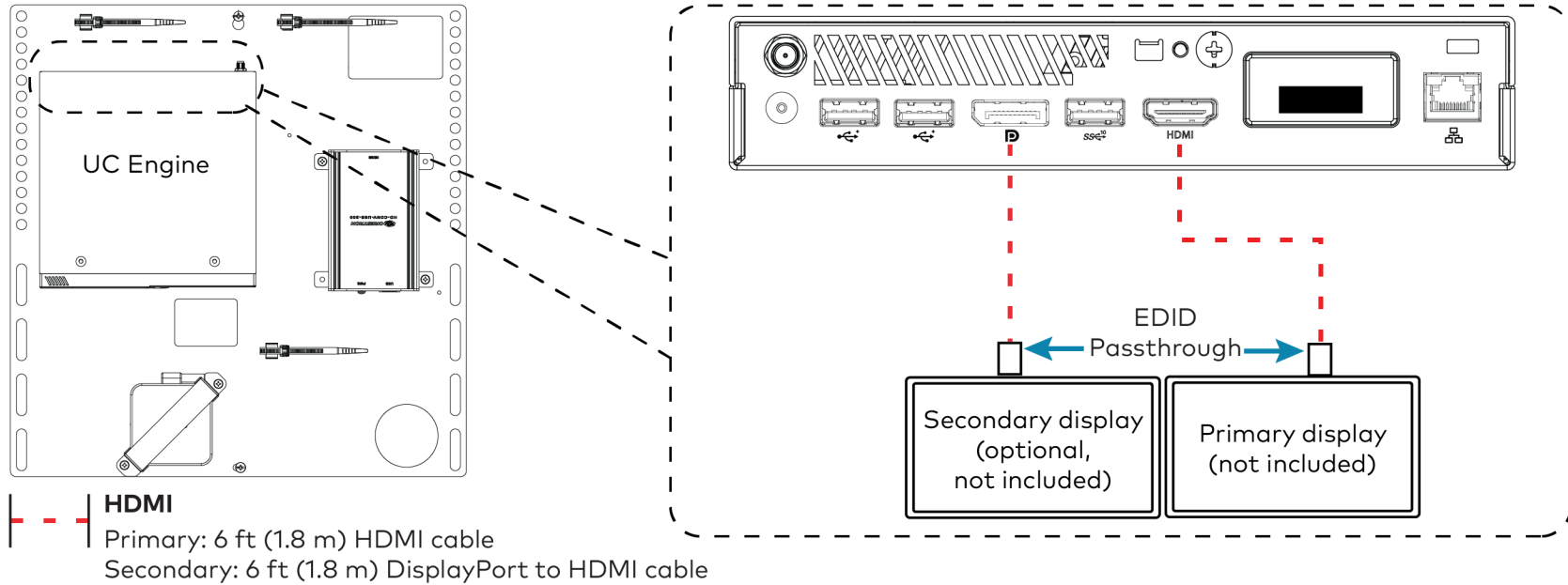

Crestron Flex Medium Room Upgrade Solution with Zoom Rooms™ Software

- Remove the screw from the connector cover (located below the UC Engine) using a Philips #1 screwdriver (not included). Open the connector cover and retain the screw.

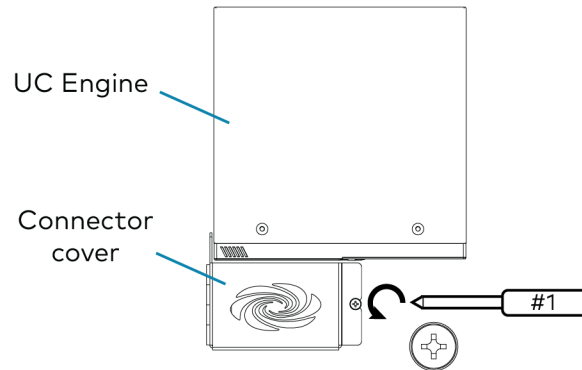

- Connect a camera (not included) to the UC Engine as shown in the image below. Do not connect the camera to any of the other USB ports.

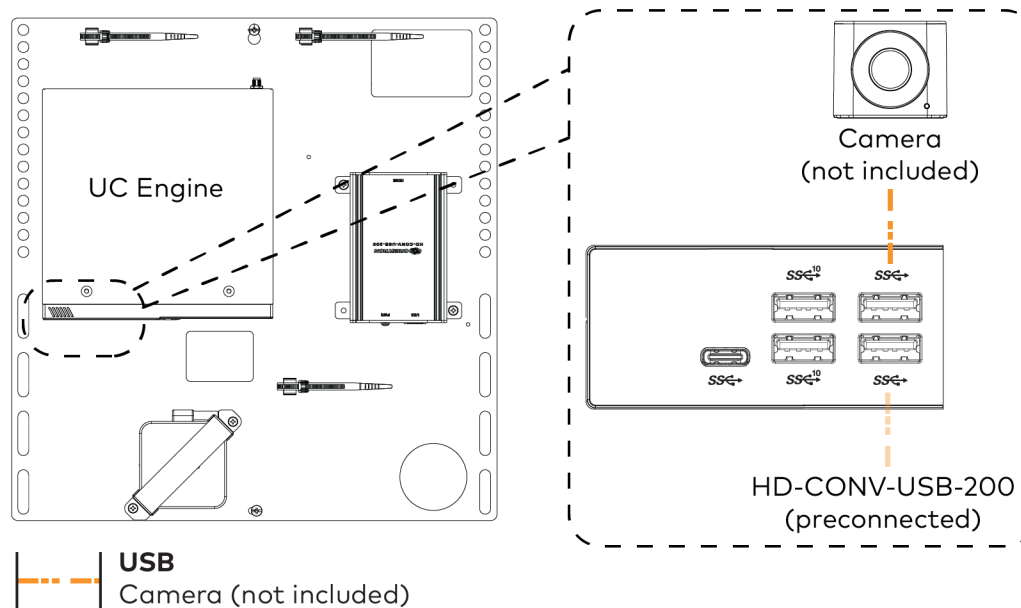

Crestron Flex Medium Room Upgrade Solution with Zoom Rooms™ Software

5. Reattach the connector cover using the screw removed in step 3.
6. Connect a laptop to the content ingest device (HD-CONV-USB-200).

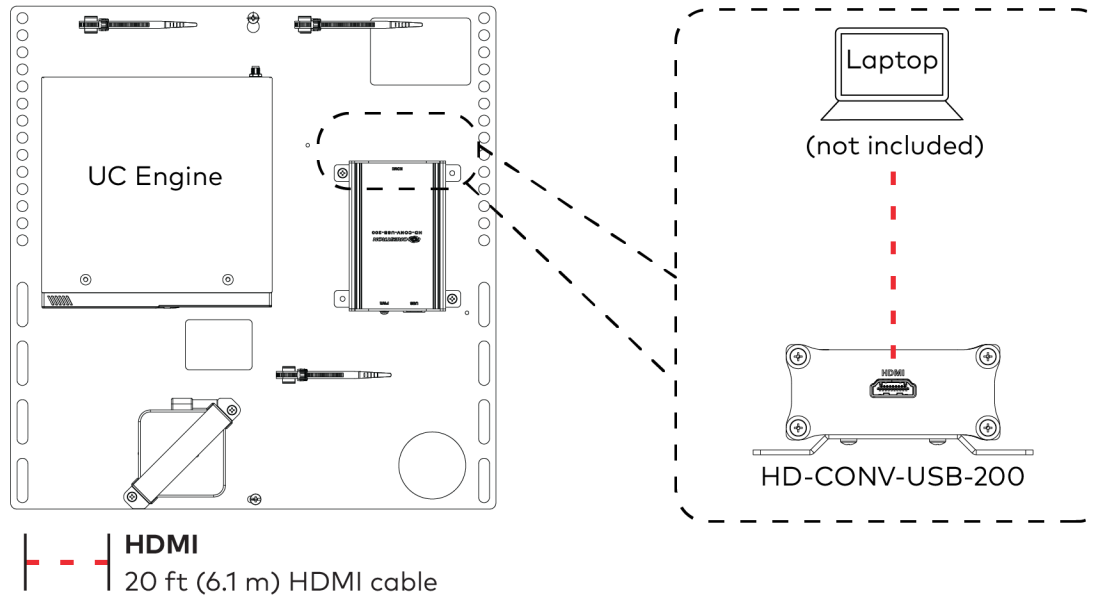

7. Bundle the cables to the bracket assembly with the integrated cable tie wraps. The cable tie wraps are reusable.

Crestron Flex Medium Room Upgrade Solution with Zoom Rooms™ Software



Bundle Cables

Bundle the cables together and use a provided tie wrap to secure the bundle to one of the positions on the cable retention plate at the rear of the device. Avoid bundling power and data cables together.

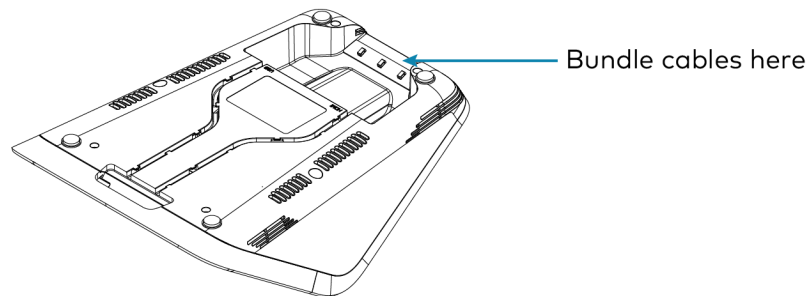

Configure

Apply Power

Press the power button on the bottom of the UC Engine and apply power to all of the other devices in the system. The connected display device will show a pairing code. The conference device will show a prompt to enter a pairing code.

Log In to the Zoom Rooms Service

Use the conference device to sign in to the Zoom Rooms service using an activation code or a Zoom Room Sign-In.

1. Enter the pairing code shown on the display to pair the device with the UC Engine. The Zoom Rooms controller app is displayed.

2. Log in to the Zoom Rooms service with an activation code or Zoom Rooms Credentials (email and password).
 - **Activation Code:**
 - a. Tap **Enter Activation Code**.
 - b. Enter the 16-digit activation code provided by the administrator to activate the Zoom Room that is assigned to the activation code. The Zoom Rooms Conference Room screen is shown on the display.
 - **Sign In:**
 - a. Tap **Sign In**.
 - b. Enter the Zoom Room credentials and tap **Sign In**.
 - c. Select the conference room name from the list and tap **Next**. The Zoom Rooms Conference Room screen is shown on the display.
3. Tap **Settings**. If a password is required, enter the password (the default password is "1234"). The **Settings** screen is displayed.
4. Tap **Microphone** and select the conference device as the source.
5. Tap **Speaker** and select the conference device as the source.
6. Tap **Meet Now** to exit.

Configure the System

Connect a USB keyboard and mouse (sold separately) to a USB port on the UC Engine to configure system features. For detailed information on using Zoom Rooms, refer to the [Zoom Rooms Help Center](#).

Crestron Flex Medium Room Upgrade Solution with Zoom Rooms™ Software



Visit the Product Page

Scan the QR code to visit the product page.

UC-M50-Z-UPGRD



www.crestron.com/model/6511958

Additional Information

Original Instructions

The U.S. English version of this document is the original instructions. All other languages are a translation of the original instructions.

Crestron product development software is licensed to Crestron dealers and Crestron Service Providers (CSPs) under a limited nonexclusive, nontransferable Software Development Tools License Agreement. Crestron product operating system software is licensed to Crestron dealers, CSPs, and end-users under a separate End-User License Agreement. Both of these Agreements can be found on the Crestron website at www.crestron.com/legal/software_license_agreement.

The product warranty can be found at www.crestron.com/warranty.

The specific patents that cover Crestron products are listed at www.crestron.com/legal/patents.

Certain Crestron products contain open source software. For specific information, visit www.crestron.com/opensource.

Crestron and the Crestron logo are either trademarks or registered trademarks of Crestron Electronics, Inc. in the United States and/or other countries. HDMI is either a trademark or registered trademark of HDMI Licensing LLC in the United States and/or other countries. USB-C is either a trademark or registered trademark of USB Implementers Forum, Inc. in the United States and/or other countries. DisplayPort and VESA are either trademarks or registered trademarks of Video Electronics Standards Association in the United States and/or other countries. Zoom Rooms is either a trademark or registered trademark of Zoom Video Communications, Inc. in the United States and/or other countries. Other trademarks, registered trademarks, and trade names may be used in this document to refer to either the entities claiming the marks and names of their products. Crestron disclaims any proprietary interest in the marks and names of others. Crestron is not responsible for errors in typography or photography.

©2022 Crestron Electronics, Inc.

Doc. 8931C

01/10/22