

## Crestron Flex Tabletop Medium Room Video Conference System for Zoom Rooms™ Software

The UC-M50-Z Crestron Flex tabletop conferencing system provides a medium room video conference solution for use with Zoom Rooms™ software. It supports up to three video displays and features a Crestron Flex tabletop conference device, UC bracket assembly, and an collaboration camera.

### Minimum Requirements:

- A video display (not included) connected to the UC Engine. A second or third display is optional.
- A Zoom Rooms account or activation code (not included)



### In the Box

#### Tabletop Conference Device

- 1 Tabletop Conference Device, Zoom Rooms Software (6508227)
- 1 Cable, CAT5e, RJ-45 - RJ-45, 12 ft (3.7 m) (2033988)
- 1 Cable Retention Plate (2047908)
- 3 Tie Wrap (2047935)

#### UC Bracket Assembly

- 1 UC Bracket Assembly with UC Engine and HDMI® content ingest (UC-BRKT-200-S-Z-ASSY, 6512690)
- 2 Anchor, Drywall, Plastic, 3/8 in. x 1/2 in. (9.5 mm x 12.7 mm) (2052565)
- 1 Key, Anchor (4529654)
- 2 Screw, 8-AB x 1-1/2 in. (38.1 mm), Pan Head, Combo (2052567)
- 4 Tie Wrap (2047935)

#### Additional Items

- 1 Collaboration camera (6510482)
- 1 Camera wall mount kit (6510998)
- 1 Cable, CAT5e, RJ-45 - RJ-45, 7 ft (2.1 m) (6509924)
- 1 Cable, DisplayPort™ to HDMI, 6 ft (1.8 m) (6508282)
- 1 Cable, HDMI, 20 ft (6.1 m) (6503567)
- 1 Cable, HDMI, 6 ft (1.8 m) (6503565)
- 1 Cable, USB 2.0, A - Micro-B, 6 ft (1.8 m) (6510947)
- 1 Cable, USB 3.0, Right angle USB-C® to A, 6 ft (1.8 m) (6511591)
- 1 Cable, USB Extension, USB Type A Male-to-Female, 15 ft (4.6 m) (6508260)
- 1 Power supply (6500187)

## Crestron Flex Tabletop Medium Room Video Conference System for Zoom Rooms™ Software



## Mount Devices

## Mount the UC Bracket Assembly

Mount the UC Bracket Assembly to VESA® compliant display devices, a wall, or other building structure. Anchors and screws are supplied for installation on walls 3/8 in. (9.5 mm) to 3/4 in. (19 mm) thickness.

**CAUTION:** Preinstalled screws may protrude from the back of the UC Bracket Assembly. Exercise caution when handling the UC Bracket Assembly to avoid scratching or damaging surfaces.

**NOTE:** The integrated cable tie wraps are reusable. Avoid damaging the cable tie wraps.

## Mount the Camera

Mount the included camera according to the [UC-CAM-WMK Quick Start](#) (Doc. 8257).



## Install the Cable Retention Plate

The included cable retention plate provides tie-down points for cables that connect to the Crestron® conference device.

Remove the adhesive backing from the cable retention plate and install the plate on the underside of the conference device as shown in the following diagram. Ensure the cable retention plate is firmly attached before securing cables.

**CAUTION:** When turning over the device, place the device on a soft surface to avoid damage.

**NOTE:** If a swivel mount kit ([CCS-UCA-SMK](#)) is to be used, use the cable retention bracket included with the swivel mount kit as described in the [CCS-UCA-SMK DO Guide](#) (Doc. 7882).

Install cable retention plate here

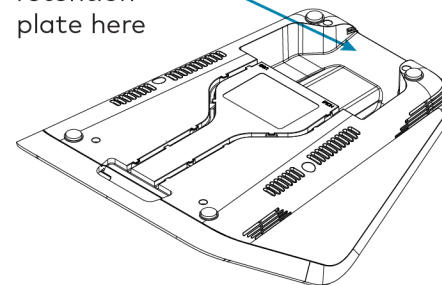

Cable retention plate installed

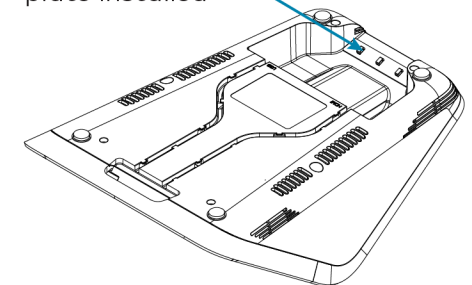

## Crestron Flex Tabletop Medium Room Video Conference System for Zoom Rooms™ Software



### Connect

### System Overview

When connections are complete, the system appears as shown below. Refer to [Make Connections](#) for detailed connection instructions.

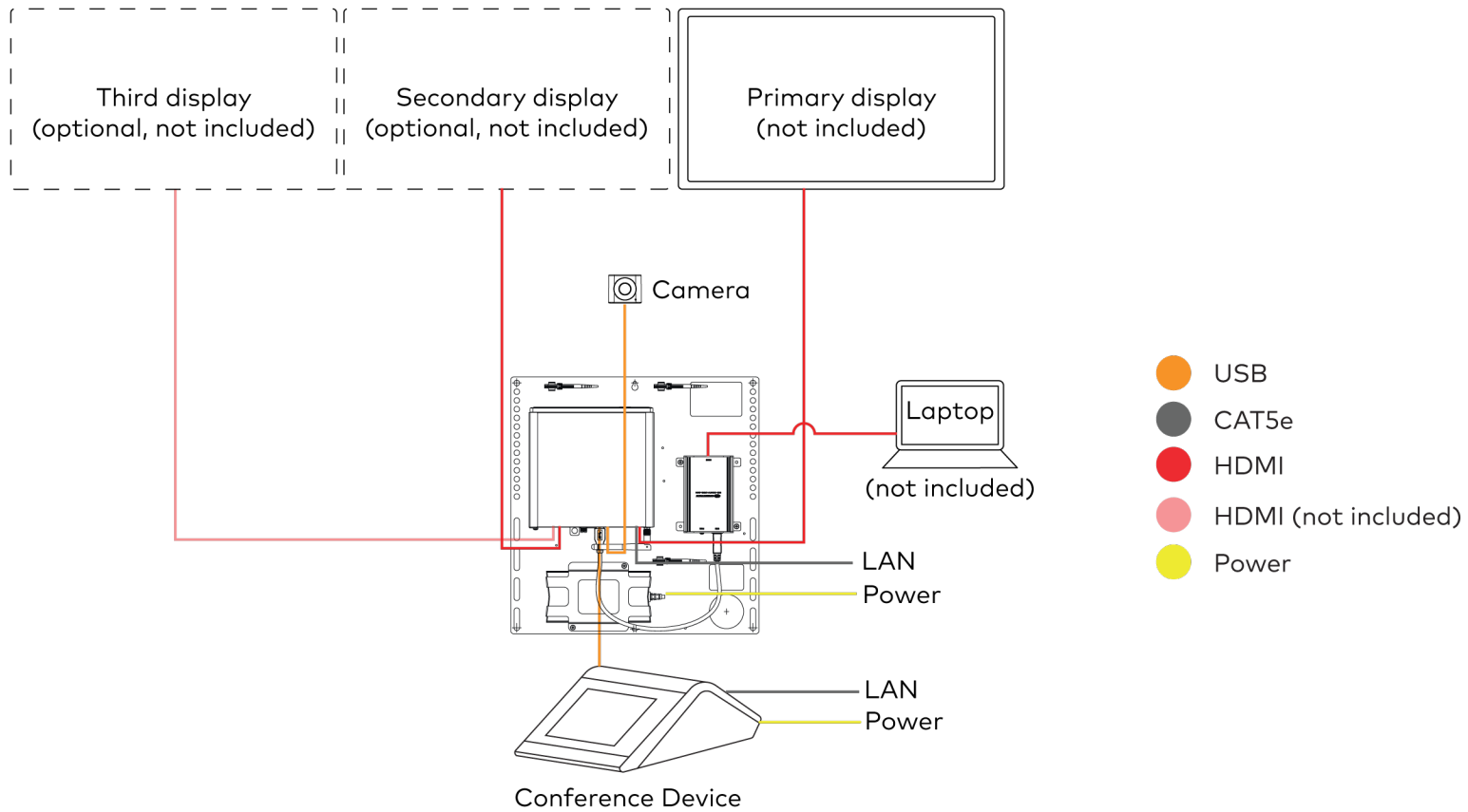

## Crestron Flex Tabletop Medium Room Video Conference System for Zoom Rooms™ Software

### Make Connections

1. Make UC Engine connections as shown in the following illustration.

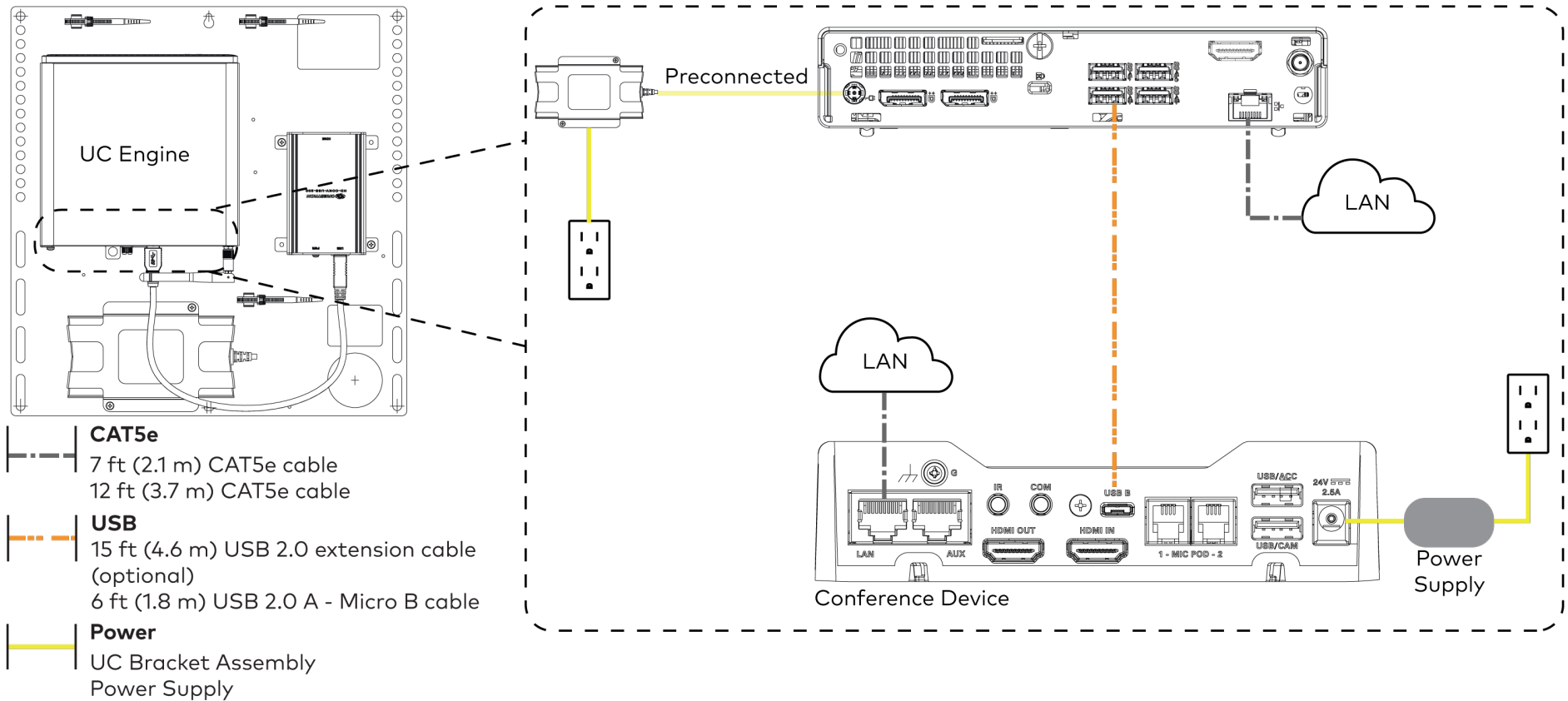

## Crestron Flex Tabletop Medium Room Video Conference System for Zoom Rooms™ Software

2. Connect displays to the UC Engine.

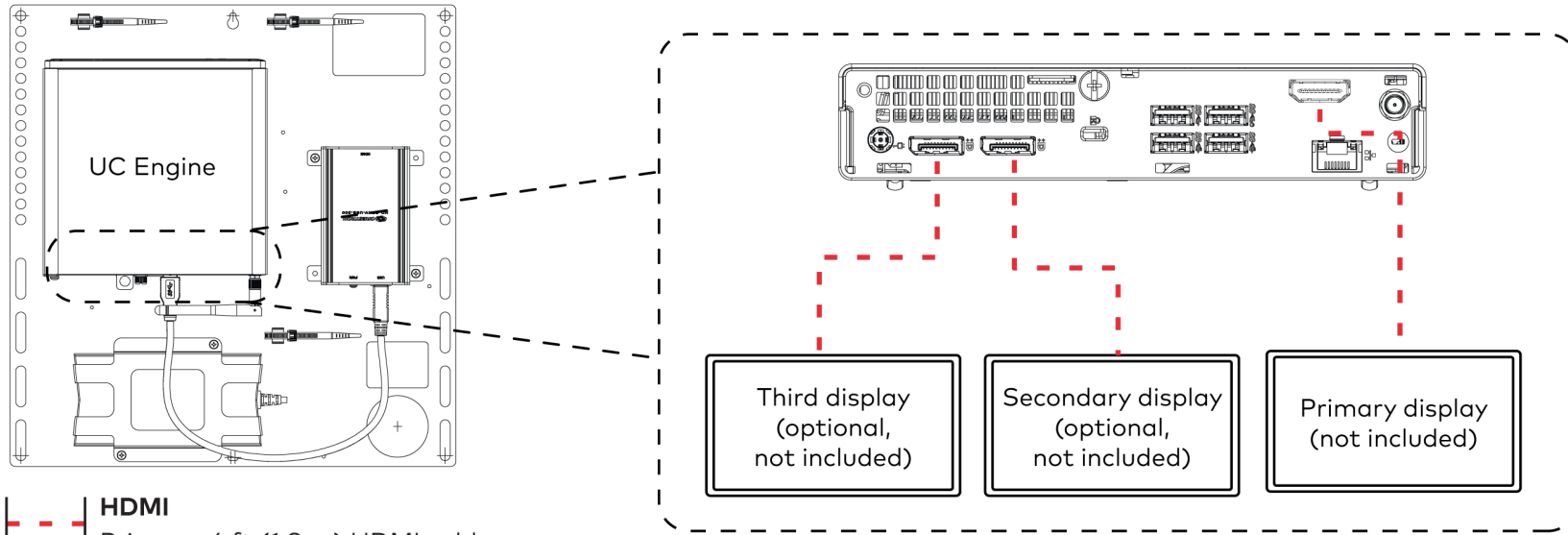

- HDMI**
- Primary: 6 ft (1.8 m) HDMI cable
  - Secondary : 6 ft (1.8 m) DisplayPort to HDMI cable
  - Third: DisplayPort to HDMI cable (not included)

## Crestron Flex Tabletop Medium Room Video Conference System for Zoom Rooms™ Software

3. Connect the camera to the UC Engine as shown in the image below. Do not connect the camera to any of the other USB ports.

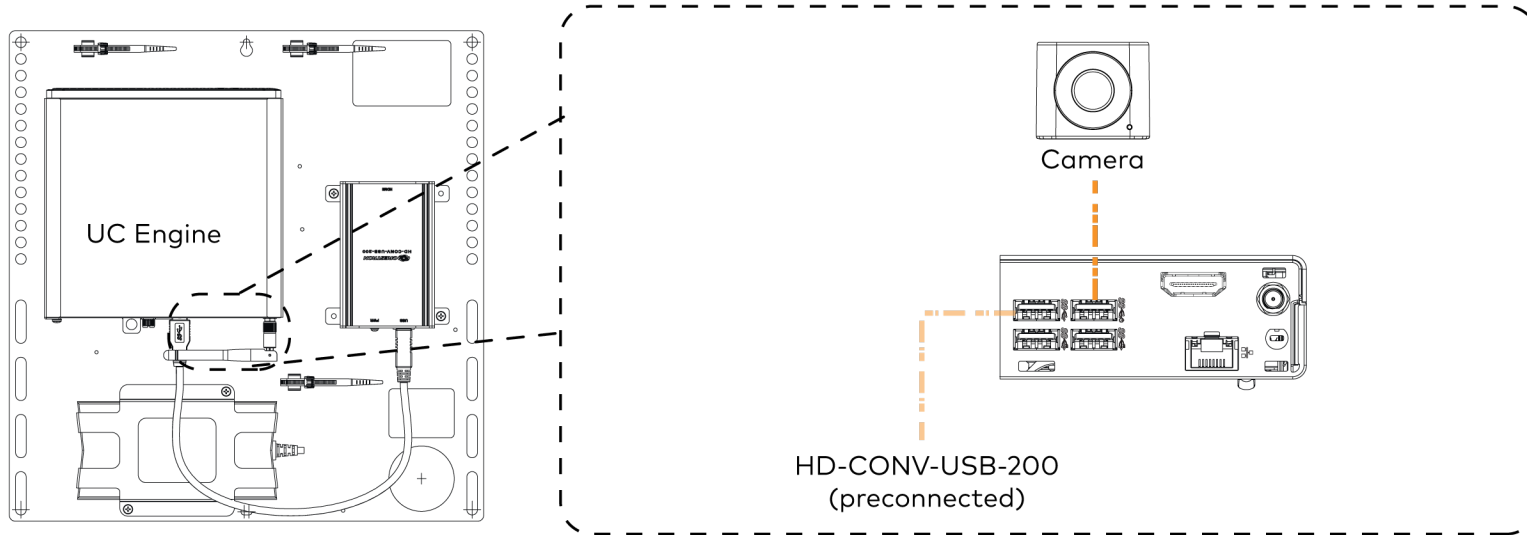

 **USB**  
6 ft (1.8 m) USB 3.0, right angle USB-C to A

## Crestron Flex Tabletop Medium Room Video Conference System for Zoom Rooms™ Software

4. Connect a laptop to the content ingest device (HD-CONV-USB-200).

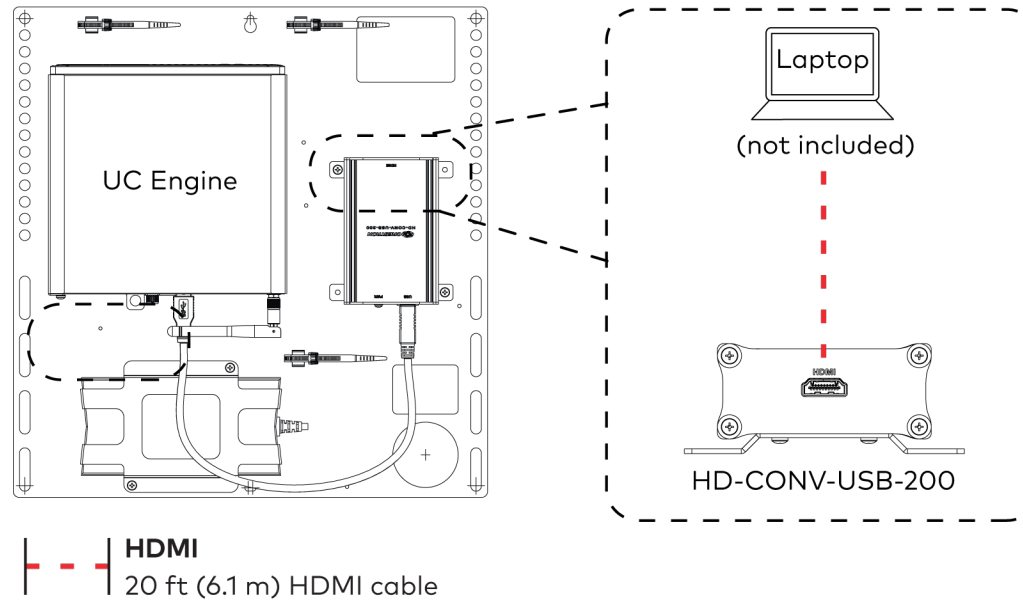

5. Bundle the cables to the bracket assembly with the integrated cable tie wraps. The cable tie wraps are reusable.

## Crestron Flex Tabletop Medium Room Video Conference System for Zoom Rooms™ Software



### Bundle Cables

Bundle the cables together and use a provided tie wrap to secure the bundle to one of the positions on the cable retention plate at the rear of the device. Avoid bundling power and data cables together.

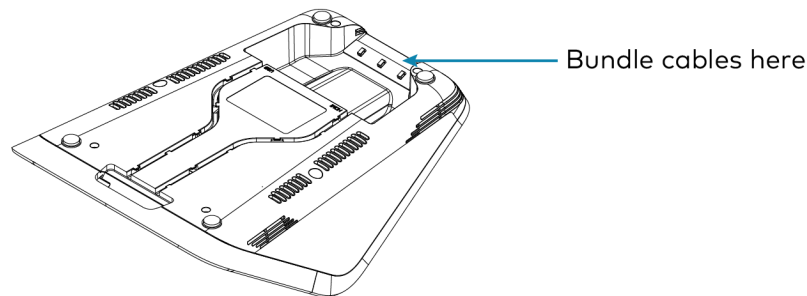

### Configure

#### Apply Power

Press the power button on the bottom of the UC Engine and apply power to all of the other devices in the system. The connected display device will show a pairing code. The conference device will show a prompt to enter a pairing code.

#### Log In to the Zoom Rooms Service

Use the conference device to sign in to the Zoom Rooms service using an activation code or a Zoom Room Sign-In.

1. Tap **Zoom** and then tap **OK**. The device will reboot.
2. Enter the pairing code shown on the display to pair the device with the UC Engine. The Zoom Rooms controller app is displayed.

3. Log in to the Zoom Rooms service with an activation code or Zoom Rooms Credentials (email and password).
  - **Activation Code:**
    - a. Tap **Enter Activation Code**.
    - b. Enter the 16-digit activation code provided by the administrator to activate the Zoom Room that is assigned to the activation code. The Zoom Rooms Conference Room screen is shown on the display.
  - **Sign In:**
    - a. Tap **Sign In**.
    - b. Enter the Zoom Room credentials and tap **Sign In**.
    - c. Select the conference room name from the list and tap **Next**. The Zoom Rooms Conference Room screen is shown on the display.
4. Tap **Settings**. If a password is required, enter the password (the default password is "1234"). The **Settings** screen is displayed.
5. Tap **Microphone** and select the conference device as the source.
6. Tap **Speaker** and select the conference device as the source.
7. Tap **Meet Now** to exit.

#### Configure the System

Connect a USB keyboard and mouse (sold separately) to a USB port on the UC Engine to configure system features. For detailed information on using Zoom Rooms, refer to the [Zoom Rooms Help Center](#).



## Crestron Flex Tabletop Medium Room Video Conference System for Zoom Rooms™ Software



## Visit the Product Page

Scan the QR code to visit the product page.

UC-M50-Z



[www.crestron.com/model/6511605](http://www.crestron.com/model/6511605)

## Additional Information

**Original Instructions**

The U.S. English version of this document is the original instructions. All other languages are a translation of the original instructions.

Crestron product development software is licensed to Crestron dealers and Crestron Service Providers (CSPs) under a limited nonexclusive, nontransferable Software Development Tools License Agreement. Crestron product operating system software is licensed to Crestron dealers, CSPs, and end-users under a separate End-User License Agreement. Both of these Agreements can be found on the Crestron website at [www.crestron.com/legal/software\\_license\\_agreement](http://www.crestron.com/legal/software_license_agreement).

The product warranty can be found at [www.crestron.com/warranty](http://www.crestron.com/warranty).

The specific patents that cover Crestron products are listed at [www.crestron.com/legal/patents](http://www.crestron.com/legal/patents).

Certain Crestron products contain open source software. For specific information, visit [www.crestron.com/opensource](http://www.crestron.com/opensource).

Crestron and the Crestron logo are either trademarks or registered trademarks of Crestron Electronics, Inc. in the United States and/or other countries. HDMI is either a trademark or registered trademark of HDMI Licensing LLC in the United States and/or other countries. USB-C is either a trademark or registered trademark of USB Implementers Forum, Inc. in the United States and/or other countries. DisplayPort and VESA are either trademarks or registered trademarks of Video Electronics Standards Association in the United States and/or other countries. Zoom Rooms is either a trademark or registered trademark of Zoom Video Communications, Inc. in the United States and/or other countries. Other trademarks, registered trademarks, and trade names may be used in this document to refer to either the entities claiming the marks and names or their products. Crestron disclaims any proprietary interest in the marks and names of others. Crestron is not responsible for errors in typography or photography.

©2022 Crestron Electronics, Inc.

Doc. 9304A

04/27/22