

Crestron **ATC-AMFM2**
Dual AM/FM Radio Tuner Card

Operations & Installation Guide



This document was prepared and written by the Technical Documentation department at:



Crestron Electronics, Inc.
15 Volvo Drive
Rockleigh, NJ 07647
1-888-CRESTRON

Regulatory Compliance

As of the date of manufacture, the ATC-AMFM2 has been tested and found to comply with specifications for CE marking and standards per EMC and Radiocommunications Compliance Labelling.



Federal Communications Commission (FCC) Compliance Statement

This device complies with part 15 of the FCC Rules. Operation is subject to the following conditions:
(1) This device may not cause harmful interference and (2) this device must accept any interference received, including interference that may cause undesired operation.

CAUTION: Changes or modifications not expressly approved by the manufacturer responsible for compliance could void the user's authority to operate the equipment.

NOTE: This equipment has been tested and found to comply with the limits for a Class B digital device, pursuant to part 15 of the FCC Rules. These limits are designed to provide reasonable protection against harmful interference in a residential installation. This equipment generates, uses and can radiate radio frequency energy and, if not installed and used in accordance with the instructions, may cause harmful interference to radio communications. However, there is no guarantee that interference will not occur in a particular installation. If this equipment does cause harmful interference to radio or television reception, which can be determined by turning the equipment off and on, the user is encouraged to try to correct the interference by one or more of the following measures:

- Reorient or relocate the receiving antenna
- Increase the separation between the equipment and receiver
- Connect the equipment into an outlet on a circuit different from that to which the receiver is connected
- Consult the dealer or an experienced radio/TV technician for help

Industry Canada (IC) Compliance Statement

Operation is subject to the following two conditions:

1. This device may not cause interference, and
 2. This device must accept any interference, including interference that may cause undesired operation of the device.
-

Contents

Dual AM/FM Radio Tuner Card: ATC-AMFM2	1
Introduction	1
Features and Functions	1
Specifications	2
Physical Description	3
Setup	5
Installation	5
Regional Configuration	6
Hardware Hookup	6
Antenna Orientation	7
Programming Software	8
Earliest Version Software Requirements for the PC	8
Programming with SystemBuilder	8
Programming with SIMPL Windows	8
Out of the Box Programming	10
Uploading and Upgrading.....	11
Establishing Communication.....	11
Firmware	11
Operation	12
Problem Solving	13
Troubleshooting.....	13
Reference Documents.....	13
Further Inquiries	13
Future Updates	14
Appendix: RDS/RBDS Function Support	15
Return and Warranty Policies	17
Merchandise Returns / Repair Service	17
CRESTRON Limited Warranty.....	17

Dual AM/FM Radio Tuner Card: ATC-AMFM2

Introduction

The ATC-AMFM2 tuner card is designed for use with the Crestron® CEN-TRACK TunerRack Modular Multi-Tuner, and with Adagio® systems that feature tuner card slots. The ATC-AMFM2 provides two fully independent AM/FM tuners on a single card.

Features and Functions

- Two independent AM/FM radios on a single plug-in card
- Plug in compatibility with Crestron host systems (CEN-TRACK, AES, AMS and AMS-AIP, all sold separately)
- RDS/RBDS compatible.*

* The Radio Data System (RDS), a European standard, and Radio Broadcast Data System (RBDS), a North American standard, permit broadcasters to use a sub-carrier frequency to transmit inaudible digital data along with their regular FM programming to receivers equipped to process the data. Refer to “Appendix: RDS/RBDS Function Support” on page 15 for more information.

Specifications

Specifications for the ATC-AMFM2 are listed in the following table.

ATC-AMFM2 Specifications

SPECIFICATION	DETAILS
Audio	
Maximum Output	1 V _{rms} @ 1kHz
FM Tuner (Typical of 2)	
Frequency Range	87.50 to 108 MHz (50 or 100 kHz steps)
Usable Sensitivity	11 dBf mono; 60 dBf stereo
S/N Ratio	64 dB @ 65 dBf mono; 56 dB @ 65 dBf stereo
IF Rejection	100 dB
AM Rejection	55 dB
Stereo Separation	27 dB
AM Tuner (Typical of 2)	
Frequency Range	530 to 1710 kHz (9 or 10 kHz steps)
Sensitivity	3.5 μV (RF input level 10 dB S+N/N)
Selectivity	10 kHz
Alternate Channel Selectivity	55 dB
Image Rejection	35 dB
IF Rejection	60 dB
Environmental	
Temperature	32° to 140° F (0° to 60° C)
Humidity	10% to 90% RH (non-condensing)
Dimensions	
Height	1.38 in (35 mm)
Width	4.91 in (125 mm)
Depth	6.19 in (158 mm)
Weight	10 oz (279 g)

Physical Description

This section provides information on the connections, controls and indicators available on the ATC-AMFM2.





ATC-AMFM2 Physical View

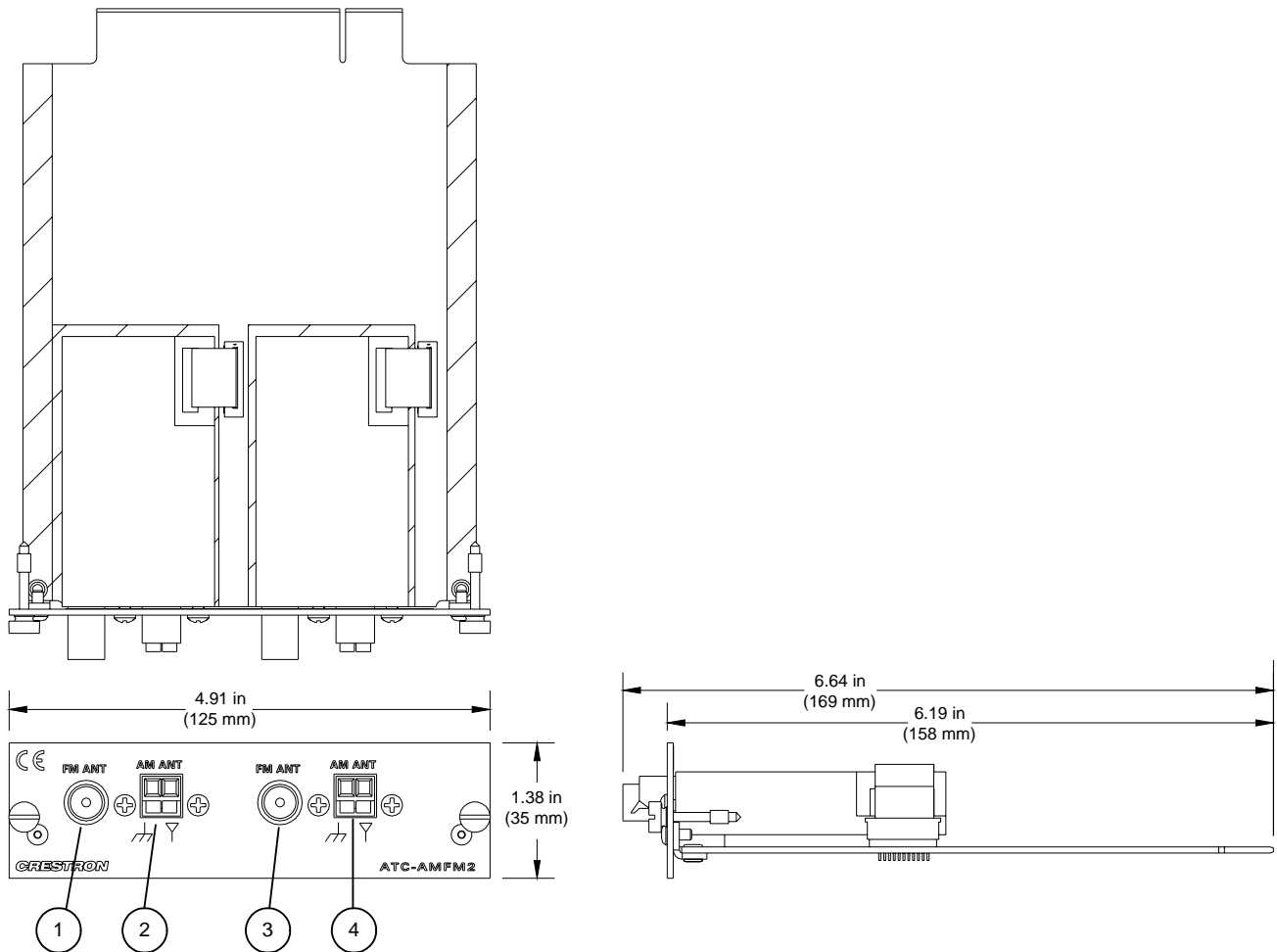

ATC-AMFM2 Overall Dimensions

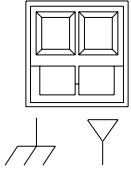

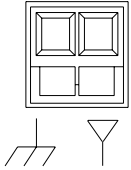
Connectors, Controls & Indicators

#	CONNECTORS, CONTROLS & INDICATORS	DESCRIPTION
1	<p>AM ANT</p> 	2-pin spring-loaded terminal; AM shielded loop antenna included; Impedance: 50 Ohms
2	<p>FM ANT</p> 	IEC 169-2 coaxial (IEC-to-F adapter included); FM wire antenna included; Impedance: 75 Ohms
3	<p>AM ANT</p> 	2-pin spring-loaded terminal; AM shielded loop antenna included; Impedance: 50 Ohms
4	<p>FM ANT</p> 	IEC 169-2 coaxial (IEC-to-F adapter included); FM wire antenna included; Impedance: 75 Ohms

Setup

This section contains hardware installation and setup instructions for the ATC-AMFM2.

Required Tools/Hardware

- Small flat blade screwdriver
- Grounding strap (encouraged)

Installation

CAUTION: The ATC-AMFM2 and host system contain electrostatic discharge (ESD) sensitive devices. Crestron encourages you to wear a grounding strap to avoid damaging the card and/or the host system.

For AES, AMS, and AMS-AIP Only

When inserting a card into an Adagio system that features tuner card slots you may need to move other source connections if designated connectors are occupied by other sources. For programming purposes, slots and source connections are matched according to the following table:

	Slot 1	Slot 2	Slot 3
Source Connections	1 & 2	3 & 4	Refer to note below

CAUTION: Do not connect external sources to **SOURCES** connectors used by tuner cards.

CAUTION: Be certain to insert tuner card before applying power to the Adagio Entertainment System.

NOTE: If the user intends to use the out-of-the-box functionality, do not use the Slot 3 for tuner cards; otherwise, use slots 5 and 6.

Procedure

To install the ATC-AMFM2:

1. Disconnect power from the host system.
2. Remove the slotted screws securing any cover plate that may be fastened to the slot you intend to use, then set the screws and the cover plate aside.
3. Unpack the ATC-AMFM2 card.

- As shown in the following photo, position the ATC-AMFM2 card so the print on the faceplate is right side up and the side rails of the card slide into the plastic slots mounted on left and right inside walls of the host system.

ATC-AMFM2 Installed in an AMS-AIP



- Push the ATC-AMFM2 card into the slot until it stops at the rear connector, and then push again until the ATC-AMFM2 card snaps into place.
- Secure the card in place by tightening the two slotted screws by hand. The screwdriver slots are provided for removal only.
- Connect antenna(s).
- Apply power.

Regional Configuration

Once the tuner card is installed, users may change tuner configuration for North American or European signal reception. For details, refer to the latest version of the host system's Operations Guide which can be downloaded from the Crestron Web site (www.crestron.com/manuals).

Hardware Hookup

Make the necessary connections as called out in the illustration that follows this paragraph. Apply power after the connections have been made.

Hardware Connections for the ATC-AMFM2

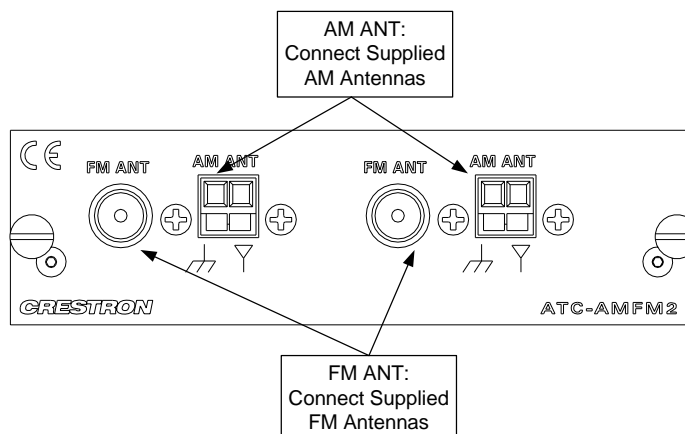

The supplied AM antenna is connected as shown in the following illustration.

AM Antenna Connection

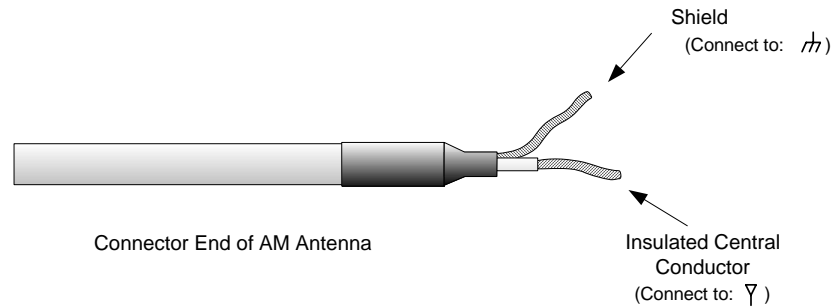

NOTE: To prevent overheating, do not operate this product in an area that exceeds the environmental temperature range listed in the table of specifications.

Antenna Orientation

AM

Once your antennas have been connected it may be necessary to orient the AM loop antenna so the flat surface of the loop antenna faces the metropolitan area from which the broadcast signals originate. This is particularly necessary when signals are weak. If you are not aware of the source or direction of the signals to which you will listen, simply rotate the loop antenna in clear space for maximum signal strength. The supplied antenna has a folding stand that allows you to place the antenna on a flat surface.

FM

The recommended FM antenna is an outdoor type commonly available in electronics stores. Use of the supplied indoor FM antenna is recommended only if you cannot use an outdoor antenna. Outdoor antennas are particularly important in rural areas, some distance from FM radio signal sources. The FM antenna supplied with your tuner is a T-type and it should be stretched horizontally in space that is as clear as possible. Some reorientation may be necessary if signals in your area are weak. Best results can usually be achieved if the length of the antenna faces the metropolitan area from which the FM signals you wish to receive originate. The supplied antenna has a fitting at its end that will enable you to fasten it in place.

The following antennas are supplied with the ATC-AMFM2:

AM Loop Antenna

FM T-Type Antenna



Programming Software

NOTE: When an ATC-AMFM2 is installed into an AES, AMS, AMS-AIP or CEN-TRACK, the host system's out-of-the-box program will provide a front panel interface for using the ATC-AMFM2. A custom program can also be created to use the features of the ATC-AMFM2.

NOTE: To ensure proper operation, download and install the latest host system firmware from crestron.com/firmware. Refer to "Uploading and Upgrading" on page 11.

Have a question or comment about Crestron software?

Answers to frequently asked questions (FAQs) can be viewed in the Online Help section of the Crestron Web site. To post a question or view questions you have submitted to Crestron's True Blue Support, log in at www.crestron.com/support. First-time users will need to establish a user account.

Earliest Version Software Requirements for the PC

NOTE: Crestron recommends that you use the latest software to take advantage of the most recently released features. The latest software is available from the Crestron Web site.

Crestron provides an assortment of Windows[®]-based software tools to develop a customized system. Use SystemBuilder™ or SIMPL Windows to create a program to control the ATC-AMFM2.

Programming with SystemBuilder

SystemBuilder is a comprehensive programming environment. Appropriate for most systems, it can quickly and easily generate a complete working program including both control processor logic and touch screen graphics.

Any program created for the ATC-AMFM2 with SystemBuilder will include the out-of-the-box functionality in addition to any additional programming created with SystemBuilder.

Programming with SIMPL Windows

NOTE: While SIMPL Windows can be used to program the ATC-AMFM2, it is recommended to use SystemBuilder for configuring a system.

SIMPL Windows is Crestron's premier software for programming Crestron control systems. It is organized into two separate but equally important "Managers": Configuration and Program.

Any SIMPL Windows program written for an AES, AMS, or AMS-AIP will contain all of the ATC-AMFM2's out-of-the-box functions in a protected area of the program. The parts of the program that contain the out-of-the-box functions are

locked and cannot be changed or deleted. When a program is compiled, the custom program plus the out-of-the-box front panel functionality, including setup menus are loaded.

NOTE: If programming an AES, AMS, or AMS-AIP, no further programming is required. Continue below if using a CEN-TRACK.

Configuration Manager

Configuration Manager is the view where programmers “build” a Crestron control system by selecting hardware from the *Device Library*.

NOTE: If programming for use in a CEN-TRACK, the CEN-TRACK must already be included as part of the system. The following instructions describe programming for an ATC-AMFM2 that is installed in a CEN-TRACK.

1. To incorporate the ATC-AMFM2 into the system, drag the CEN-TRACK-AMFM2 from the Plug-in Control Cards | Cards (CEN-TRACK) folder of the *Device Library* and drop it on to a CEN-TRACK in the *System Views*.

Locating the ATC-AMFM2 in the Device Library

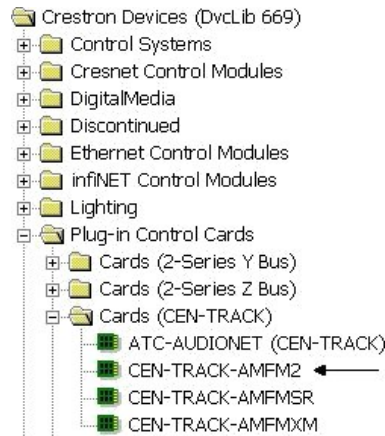

The system tree of the control system displays the device in the CEN-TRACK as shown in the following illustration.

CEN-TRACK, Slot 1

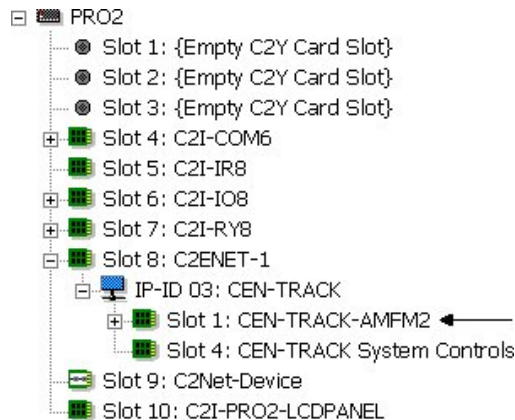

NOTE: The first tuner card added to a CEN-TRACK is assigned to slot 1. The tuner card must be physically installed in the assigned slot.

2. If additional ATC-AMFM2 devices are to be added, repeat step 1 for each device. Each ATC-AMFM2 is assigned a different slot as it is added.

Program Manager

Program Manager is the view where programmers “program” a Crestron control system by assigning signals to symbols.

Signals that are part of the ATC-AMFM2’s out-of-the-box functionality are locked and cannot be modified or deleted. Locked signals are grayed out in the ATC-AMFM2’s SIMPL Windows symbols. To prevent corruption of the out-of-the-box functionality, locked signal names should not be copied or driven to other destinations in the SIMPL Windows program.

The symbol can be viewed by double clicking on the icon or dragging it into *Detail View*. Each signal in the symbol is described in the SIMPL Windows help file (**F1**).

Out of the Box Programming

For out-of-the-box programming information, refer to the manual for the device into which the ATC-AMFM2 is installed.

Uploading and Upgrading

Crestron recommends using the latest programming software and that each device contains the latest firmware to take advantage of the most recently released features. However, before attempting to upload or upgrade it is necessary to establish communication. Once communication has been established, files (for example, programs or firmware) can be transferred to the control system (and/or device). Finally, program checks can be performed (such as changing the device ID or creating an IP table) to ensure proper functioning.

Establishing Communication

Refer to the latest version of the host system's Operations Guide for details.

Firmware

Firmware files may be distributed from programmers to installers or from Crestron to dealers. Firmware upgrades are available from the Crestron Web site as new features are developed after product releases. For details on upgrading refer to the Crestron Toolbox™ help file.

Upgrade ATC-AMFM2 firmware via Crestron Toolbox.

1. Establish communication with the host system and display the "System Info" window.
2. Select **Functions | Firmware...** to upgrade the host system's firmware.

Operation

For details on controlling the ATC-AMFM2, refer to the latest version of the host system's Operations Guide.

Problem Solving

Troubleshooting

The following table provides corrective action for possible trouble situations. If further assistance is required, please contact a Crestron customer service representative.

ATC-AMFM2 Troubleshooting

TROUBLE	POSSIBLE CAUSE(S)	CORRECTIVE ACTION
Tuner muted.	Mismatched slot.	Place card in proper slot.
	Mute turned on.	Press the Mute button to disengage muting.
	Adagio system volume is turned down.	Check Adagio system volume setting.
	Antenna not connected or not connected properly.	Connect antenna according to instructions.
Cannot access tuner card controls from front panel.	Dusty contacts on ATC-AMFM2.	Clean contacts with cotton swab or clean cloth. Apply Isopropyl alcohol as needed for cleaning.
Tuner produces noise.	Improperly connected antenna.	Connect antenna according to instructions.
Scan does not operate.	Station signal strength too weak.	Check antenna placement for good signal strength.

Reference Documents

The latest version of all documents mentioned within the guide can be obtained from the Crestron Web site (www.crestron.com/manuals). This link will provide a list of product manuals arranged in alphabetical order by model number.

List of Related Reference Documents

DOCUMENT TITLE
AES Adagio Entertainment System
AMS Adagio Media System
AMS-AIP Adagio Media System with Advance Image Processing
CEN-TRACK TunerRack Modular Multi-Tuner

Further Inquiries

If you cannot locate specific information or have questions after reviewing this guide, please take advantage of Crestron's award winning customer service team by calling Crestron at 1-888-CRESTRON [1-888-273-7876]. For assistance in your region, please refer to the Crestron Web site (www.crestron.com) for a listing of Crestron worldwide offices.

You can also log onto the online help section of the Crestron Web site (www.crestron.com/onlinehelp) to ask questions about Crestron products. First-time users will need to establish a user account to fully benefit from all available features.

Future Updates

As Crestron improves functions, adds new features and extends the capabilities of the ATC-AMFM2, additional information may be made available as manual updates. These updates are solely electronic and serve as intermediary supplements prior to the release of a complete technical documentation revision.

Check the Crestron Web site periodically for manual update availability and its relevance. Updates are identified as an “Addendum” in the Download column.

Appendix: RDS/RBDS Function Support

Many radio stations transmit additional information, such as traffic information, radio text, real time clock etc., with their regular FM programming. The FM tuner contains circuitry that retrieves this information.

The US format for such information is called the Radio Broadcast Data System (RBDS), and in Europe this format is called the Radio Data System (RDS). There are some differences between the US and European standards.

The tables in this appendix describe information included in the standard.

When this feature becomes available and accessed by the user, the **Display** button will bring to the screen the various tables containing this data.

RDS/RBDS Supported Feature Overview

FEATURES	DESCRIPTION
Program type name (PTY)	There are 31 program types such as jazz, classic etc. Each station that supports RDS will report its program type. (Refer to program type list following this table.)
Program service name (PS)	The station reports its service name such as WIRL, KTU etc.
Program type additional Info (PTYN)	The station sometimes will report additional information about its program type. For example, a program type "Sport" station may report a PTYN of "Football".
Radio text display support (RT)	The station will report radio text information such as phone numbers, artist, song, stations name, etc., in this field. This field could be either 32 or 64 characters.
Universal real time clock (UTC)	Some stations transmit the universal time clock year, month, day, hour, minute, and GMT offset.
Traffic information report (TA/TP)	The stations that support the traffic information.
Station search by TA, TP or TA & TP traffic information types	The FM Tuner can search for stations, which either broadcast or know about other stations that transmit the traffic information. TA = This station has information about other station which carries the traffic announcements. TP = This station broadcasts traffic announcements, but none is being broadcasted right now. TA&TP = This station is currently broadcasting the traffic announcements.
Station search by PTY	The FM Tuner is able to search for station with specified program type.

RBDS/RDS Program Types

PTY CODE	RBDS PROGRAM TYPE (US)	RDS PROGRAM TYPE (EUROPE)
0	No program type or undefined	No program type or undefined
1	News	News
2	Information	Current Affair
3	Sports	Information
4	Talk	Sports
5	Rock	Education
6	Classic Rock	Drama
7	Adult Hits	Culture
8	Soft Rock	Science
9	Top 40	Varied
10	Country	Pop Music
11	Oldies	Rock Music
12	Soft	M.O.R Music
13	Nostalgia	Light classical
14	Jazz	Serious Classic
15	Classical	Other Music
16	Rhythm and Blues	Weather
17	Soft Rhythm and Blues	Finance
18	Language	Children's Program
19	Religious Music	Social Affairs
20	Religious Talk	Religion
21	Personality	Phone In
22	Public	Travel
23	College	Leisure
24	Unassigned	Jazz Music
25	Unassigned	Country Music
26	Unassigned	National Music
27	Unassigned	Oldies Music
28	Unassigned	Folk Music
29	Weather	Documentary
30	Emergency Text	Alarm Test
31	Emergency	Alarm

Return and Warranty Policies

Merchandise Returns / Repair Service

1. No merchandise may be returned for credit, exchange or service without prior authorization from CRESTRON. To obtain warranty service for CRESTRON products, contact an authorized CRESTRON dealer. Only authorized CRESTRON dealers may contact the factory and request an RMA (Return Merchandise Authorization) number. Enclose a note specifying the nature of the problem, name and phone number of contact person, RMA number and return address.
2. Products may be returned for credit, exchange or service with a CRESTRON Return Merchandise Authorization (RMA) number. Authorized returns must be shipped freight prepaid to CRESTRON, 6 Volvo Drive, Rockleigh, N.J. or its authorized subsidiaries, with RMA number clearly marked on the outside of all cartons. Shipments arriving freight collect or without an RMA number shall be subject to refusal. CRESTRON reserves the right in its sole and absolute discretion to charge a 15% restocking fee plus shipping costs on any products returned with an RMA.
3. Return freight charges following repair of items under warranty shall be paid by CRESTRON, shipping by standard ground carrier. In the event repairs are found to be non-warranty, return freight costs shall be paid by the purchaser.

CRESTRON Limited Warranty

CRESTRON ELECTRONICS, Inc. warrants its products to be free from manufacturing defects in materials and workmanship under normal use for a period of three (3) years from the date of purchase from CRESTRON, with the following exceptions: disk drives and any other moving or rotating mechanical parts, pan/tilt heads and power supplies are covered for a period of one (1) year; touch screen display and overlay components are covered for 90 days; batteries and incandescent lamps are not covered.

This warranty extends to products purchased directly from CRESTRON or an authorized CRESTRON dealer. Purchasers should inquire of the dealer regarding the nature and extent of the dealer's warranty, if any.

CRESTRON shall not be liable to honor the terms of this warranty if the product has been used in any application other than that for which it was intended or if it has been subjected to misuse, accidental damage, modification or improper installation procedures. Furthermore, this warranty does not cover any product that has had the serial number altered, defaced or removed.

This warranty shall be the sole and exclusive remedy to the original purchaser. In no event shall CRESTRON be liable for incidental or consequential damages of any kind (property or economic damages inclusive) arising from the sale or use of this equipment. CRESTRON is not liable for any claim made by a third party or made by the purchaser for a third party.

CRESTRON shall, at its option, repair or replace any product found defective, without charge for parts or labor. Repaired or replaced equipment and parts supplied under this warranty shall be covered only by the unexpired portion of the warranty.

Except as expressly set forth in this warranty, CRESTRON makes no other warranties, expressed or implied, nor authorizes any other party to offer any warranty, including any implied warranties of merchantability or fitness for a particular purpose. Any implied warranties that may be imposed by law are limited to the terms of this limited warranty. This warranty statement supersedes all previous warranties.

This page is intentionally left blank.

This page is intentionally left blank.



Crestron Electronics, Inc.
15 Volvo Drive Rockleigh, NJ 07647
Tel: 888.CRESTRON
Fax: 201.767.7576
www.crestron.com

**Operations & Installation Guide – DOC. 7216A
(2031139)
08.11**
Specifications subject to
change without notice.