

Crestron **TPMC-8X-GA**
Isys[®] 8.4" WiFi Touch Screen

Operations Guide



This document was prepared and written by the Technical Documentation department at:



Regulatory Compliance

As of the date of manufacture, the TPMC-8X-GA has been tested and found to comply with specifications for CE marking and standards per EMC and Radiocommunications Compliance Labelling.



Federal Communications Commission (FCC) Compliance Statement

This device complies with part 15 of the FCC Rules. Operation is subject to the following conditions: (1) This device may not cause harmful interference and (2) this device must accept any interference received, including interference that may cause undesired operation.

CAUTION: Changes or modifications not expressly approved by the manufacturer responsible for compliance could void the user's authority to operate the equipment.

NOTE: This equipment has been tested and found to comply with the limits for a Class B digital device, pursuant to part 15 of the FCC Rules. These limits are designed to provide reasonable protection against harmful interference in a residential installation. This equipment generates, uses and can radiate radio frequency energy and, if not installed and used in accordance with the instructions, may cause harmful interference to radio communications. However, there is no guarantee that interference will not occur in a particular installation. If this equipment does cause harmful interference to radio or television reception, which can be determined by turning the equipment off and on, the user is encouraged to try to correct the interference by one or more of the following measures:

- Reorient or relocate the receiving antenna
- Increase the separation between the equipment and receiver
- Connect the equipment into an outlet on a circuit different from that to which the receiver is connected
- Consult the dealer or an experienced radio/TV technician for help

Industry Canada (IC) Compliance Statement

Operation is subject to the following two conditions:

1. This device may not cause interference, and
2. This device must accept any interference, including interference that may cause undesired operation of the device.

To satisfy RF exposure requirements, this device and its antenna must operate with a separation distance of at least 20 centimeters from all persons and must not be colocated or operating in conjunction with any other antenna or transmitter.

The specific patents that cover Crestron products are listed at www.crestronpatents.com.

Crestron, the Crestron logo, ADMS Intermedia Delivery System, Core 3, Core 3 UI, Crestron Toolbox, Crestron VisionTools, Isys, Rava, SmartObjects, SmartScaling, SystemBuilder, TouchPoint and VT Pro-e are either trademarks or registered trademarks of Crestron Electronics, Inc. in the United States and/or other countries. Acrobat, Adobe and Flash are either trademarks or registered trademarks of Adobe Systems Incorporated in the United States and/or other countries. Cisco is a registered trademark of Cisco Systems, Inc. and/or its affiliates in the United States and certain other countries. Java is either a trademark or registered trademark of Oracle America, Inc. in the United States and/or other countries. Microsoft, Excel, Internet Explorer, NetMeeting, PowerPoint, Windows, Windows Media and XP are either trademarks or registered trademarks of Microsoft Corporation in the United States and/or other countries. Netflix and the Netflix logo are either trademarks or registered trademarks of Netflix, Inc. YouTube is either a trademark or registered trademark of Google, Inc. in the United States and/or other countries. Other trademarks, registered trademarks and trade names may be used in this document to refer to either the entities claiming the marks and names or their products. Crestron disclaims any proprietary interest in the marks and names of others.

©2011 Crestron Electronics, Inc.

Contents

Isys[®] 8.4" WiFi Touch Screen: TPMC-8X-GA	1
Introduction	1
Features and Functions	1
Specifications	5
Physical Description	8
Setup	12
Identity Code	12
Internal Battery Switch	12
Configuring the Touch Screen	13
Hardware Hookup	38
Recommended Cleaning	38
Programming Software	39
Earliest Version Software Requirements for the PC	39
Programming with SystemBuilder	39
Programming with SIMPL Windows	39
Programming with VisionTools Pro-e	41
Embedded Applications	44
Defaults for Embedded Windows Applications	45
Programming Embedded Windows Applications	45
Uploading and Upgrading	47
Establishing Communication	47
Programs, Projects and Firmware	47
Program Checks	48
Restore	48
Operation	49
Power Options	49
Charging the Internal Battery	50
Security Infrastructure	50
Problem Solving	52
Troubleshooting	52
Reference Documents	53
Further Inquiries	54
Future Updates	54
Appendix: TPMC-8X-GA Security Pack	55
Return and Warranty Policies	59
Merchandise Returns / Repair Service	59
Crestron Limited Warranty	59
Microsoft [®] Windows XP [®] Embedded End User License Agreement	60

Isys® 8.4" WiFi Touch Screen: TPMC-8X-GA

Introduction

Sleek, rugged and lightweight, the Isys® TPMC-8X-GA from Crestron® is brilliantly designed to provide a powerful mobile control solution that is easy to hold and intuitive to use. This stylish Wi-Fi touch screen offers enhanced wireless performance, onboard multimedia and Web browsing, high performance H.264 video¹, Rava™ SIP Intercom¹ and advanced Core 3 UI™ touch screen graphics. Its brilliant 8.4" (213 mm) SVGA display and high powered speakers afford an amazing personal media experience on top of its astounding custom control capabilities.

Features and Functions

- Stylish and compact ergonomic design
- 8.4 in (213 mm) active matrix touch screen display
- 800 x 600 SVGA display resolution
- 16-bit color graphics powered by Core 3™
- Automatic display brightness control
- High performance 802.11a/b/g Wi-Fi wireless communications
- Up to 80 feet (~24 meters) omnidirectional RF range²
- Onboard PC applications for Web browsing, playing digital media and viewing digital documents
- VNC viewer for remotely accessing and controlling external computers
- Native H.264 streaming video for viewing Web cameras and HD sources¹
- Rava SIP Intercom and telephone technology¹
- WAV file customizable audio feedback
- High powered speakers, headphone jack and microphone
- 5-way thumbpad, up/down arrow buttons and four "hard keys"
- Stylus with built-in storage slot

(Continued on following page)

1. Support for H.264 video and Rava SIP Intercom are future features that will be enabled through a future firmware release.
2. Refer to "Specifications" which starts on page 5 for full wireless range details.

Features and Functions

(Continued)

- On-screen mouse and keyboard capability
- USB port for external mouse and keyboard¹
- Intelligent power management for “wake on touch”
- Internal Li-Ion battery pack included
- External “booster” battery pack available (sold separately)²
- Optional desktop and wall mount docking stations (sold separately)³

Advanced Touch Screen Control

A Crestron touch screen offers an ideal user interface for controlling all the technology in your home, boardroom, classroom, courtroom or command center. Touch screens do away with piles of remote controls, cluttered wall switches and cryptic computer screens, simplifying and enhancing the way you use technology. Crestron touch screens are fully customizable for controlling home theater, multimedia presentation, audio, video, lighting, HVAC and other systems – with easy to use controls and icons, true feedback and real time status display, full motion video windows and advanced navigation of digital media servers, tuners and other devices.

Powered by Core 3

Crestron touch screens have always offered the ultimate user experience. With Core 3 UI, they also deliver the ultimate value, enabling the creation of dynamically rich user interfaces with incredible efficiency and unparalleled functionality. Using Core 3 UI, programmers can swiftly integrate fluid gesture driven controls, animated feedback, metadata, embedded apps and full motion video for a deeply engaging and ultra-intuitive touch screen experience.

Some Core 3 UI enhancements:

- Cool looking graphical buttons, sliders, knobs and gauges are intuitive and fun to use.
- Kinetic effects enhance the feeling of realism with lists and toolbars that scroll with momentum at the flick of a fingertip.
- Drag and drop objects snap into place offering an easy way to assign AV sources to rooms.
- Desktop widgets personalize the touch screen with animated clocks, calendars, weather, news and other information.
- Customizable themes allow a completely different look and feel for every user, event or season.
- Fully developed SmartObjects™ enable sophisticated control over complex devices with minimal programming.
- SmartScaling™ resizes objects perfectly and instantly for faster GUI development, even across different sized touch screens.

1. USB mouse/keyboard not included.

2. External battery pack allows ~3.5 hours continuous, 20+ hours under normal use.

3. Requires TPMC-8X-DSW (material # 6504859). Owners of older TPMC-8X-DSW must contact Crestron Customer Support to acquire the TPMC-8X-DSW Bezel Conversion Kit (material #6505136).

Wireless Streaming Video

Streaming video capability makes it possible to view security cameras and other video sources right on the touch screen display. Native support for H.264¹ and MJPEG formats allows the TPMC-8X-GA to display live video images from Web cameras and servers such as the Crestron CEN-NVS200 Network Video Streamer (sold separately). Through its embedded Web browser and media player, it supports a variety of other streaming and downloadable video formats, enabling access to all kinds of content from media servers and Web sites like YouTube[™] and Netflix^{®2}.

Rava SIP Intercom

Rava SIP intercom¹ technology enables hands-free VoIP communication between any two Rava enabled Crestron touch screens. Rava works over Wi-Fi or wired Ethernet, supporting 2-way intercom, video intercom³, paging and room monitoring without any special wiring. VoIP phone capability is also possible through integration with a SIP compatible IP phone system or SIP server, allowing hands-free telephone functionality complete with speed dialing, caller ID, custom ringers and other enhancements. Built-in echo cancellation affords true duplex performance for clear, seamless voice communication using the TPMC-8X-GA's integrated microphone and speakers¹.

Embedded PC Applications

The TPMC-8X-GA provides everything you need to enjoy online music and videos, browse the Internet and even review digital documents without a separate computer. With Microsoft[®] Internet Explorer[®] embedded, you have full access to the entire World Wide Web including sites that use Flash[®] or Java[™]. Windows Media[®] Player ensures broad compatibility for playing most types of digital media and lets you use the TPMC-8X-GA as a personal media player. Adobe[®] Acrobat[®] Reader and Microsoft PowerPoint[®], Word and Excel[®] document viewers complete the online experience, allowing you to download and view documents and presentations.

In addition, VNC Viewer support delivers enhanced cross-platform interaction with computers over the network or Internet, allowing remote access and control of desktop applications to unleash a host of possibilities for system integration and multimedia presentation.

Speakers and Microphone

High powered built-in speakers and headphone output provide loud and clear audio for enjoying multimedia, as well as for intercom and phone in combination with the integrated microphone. Customized WAV files can also be loaded on the TPMC-8X-GA to add dimension to the touch screen graphics with personalized sounds, button feedback and voice prompts.

Tactile Controls

The integrated 5-way thumbpad and up/down arrow buttons afford quick access and tactile response for controlling functions such as volume adjustment, channel selection and on-screen menu navigation and even pan/tilt/zoom camera control. Four additional "hard key" buttons are positioned below the touch screen, programmable for functions that can change right along with the virtual controls on the touch screen. A stylus is even included for use with the on-screen keyboard, conveniently stowed in its own storage slot.

1. Support for H.264 video and Rava SIP Intercom are future features that will be enabled through a future firmware release.
2. Accessing Netflix content requires an active Netflix account. Refer to www.netflix.com for details.
3. H.264 compatible IP camera required.

Keyboard/Mouse Options

On-screen keyboard and mouse capabilities enable complete control of the TPMC-8X-GA's embedded Web browser and other applications. It can also be used to control external network devices like the Crestron ADMS Intermedia Delivery System™ (sold separately) as well as computers running TouchPoint™ Virtual Mouse & Keyboard Software (VMK-WIN, sold separately). A USB port is also provided for the connection of a physical keyboard and mouse.¹

Wi-Fi Performance - Redefined

Crestron has redefined W-Fi wireless performance with the TPMC-8X-GA, achieving a remarkable 80 feet (~24 meters) omnidirectional range² for exceptional freedom of movement. The choice of 802.11 a, b and g protocols affords reliable, high speed 2-way wireless performance in virtually any RF environment. It takes mere minutes to configure the TPMC-8X-GA for use with a Crestron CEN-WAP-ABG Wireless Access Point (sold separately) for a simple, secure Wi-Fi touch screen network solution.

Battery Saving Enhancements

Fast charging, long lasting wireless operation is afforded by an internal field replaceable Lithium Ion battery pack (TPMC-8X-BTP³). Over nine hours of typical use is possible between charges thanks to intelligent onboard power management and auto-brightness control.

- **Auto-Brightness** – smoothly maintains optimal visibility under varying lighting conditions while preserving precious battery life.
- **Standby Mode** – turns off the touch screen display to save power while the hard buttons remain active. Allows adjustment of volume or channel changes by pressing a hard button without waking the screen.
- **Power Down Mode** – suspends the touch screen during prolonged periods of non-use. Allows waking the touch screen by simply touching the screen or pressing the side “Power” button.
- **Class D Amplifier** – provides loud and clear audio without draining the battery.

An external “booster” battery pack is also available, providing up to 20 hours of typical use between charges.⁴ The optional external battery pack (TPMC-8X-BTPE, sold separately) clips neatly to the rear of the touch screen without tools, providing non-slip rubber feet and a seven degree tilt angle for enhanced tabletop operation.

Docking Station Options

Optional desktop and wall mount docking stations are offered, each designed to enable full use of the touch screen while charging its battery (or batteries). The Desktop Docking Station (TPMC-8X-DS, sold separately) allows the touch screen to be operated upright at a 37 degree angle, while the Wall Mount Docking Station (TPMC-8X-DSW⁵, sold separately) achieves a flush in-wall appearance. Both options afford wired Ethernet and expanded USB connectivity. The wall option also includes an audio output for integration with an external sound system.

1. USB mouse/keyboard not included.
2. Refer to “Specifications” which starts on page 5 for full wireless range details.
3. Item included, refer to individual product specifications for complete details.
4. External battery pack allows ~3.5 hours continuous, 20+ hours under normal use.
5. Requires TPMC-8X-DSW (material # 6504859). Owners of older TPMC-8X-DSW must contact Crestron Customer Support to acquire the TPMC-8X-DSW Bezel Conversion Kit (material #6505136).

Specifications

Specifications for the TPMC-8X-GA are listed in the following table.

TPMC-8X-GA Specifications

SPECIFICATION	DETAILS
Touch Screen Display Display Type Size Aspect Ratio Resolution Brightness Contrast Color Depth Illumination Viewing Angle ¹ Touch Screen	TFT active matrix color LCD 8.4 inch (213 mm) diagonal 4:3 SVGA 800 x 600 pixels 200 nits 500:1 18-bit, 262k colors Edgelit fluorescent with auto-brightness ±65° horizontal, +65°/-45° vertical Resistive membrane
Memory DDR2 SDRAM Flash Memory Card Maximum Project Size	1 GB 4 GB Accepts up to 32 GB MMC compatible card (not included) 190 MB
Graphic Engine ²	Core 3 UI, 16-bit color depth (non-palette), VT Pro-e [®] programmable, supports Core 3 projects
Embedded PC Applications ³	Microsoft Internet Explorer with Adobe Flash plug-in and Java Runtime plug-in, Windows Media Player, Crestron MJPEG Viewer, VNC Viewer ⁴ , Remote Desktop, Crestron Keyboard, Adobe Acrobat Reader, WordPad, MS Word Viewer 2003, Excel Viewer 2003, PowerPoint Viewer 2003
Wireless Communication ³ Transceiver Range Gateway Roaming	IEEE 802.11a/b/g Wi-Fi, 5.8 or 2.4 GHz 2-way RF, static IP or dynamic IP via DHCP, 64 and 128-bit WEP encryption Up to 80 feet (~24 meters) omnidirectional using 802.11b/g, 35 feet (~11 meters) omnidirectional using 802.11a, @ 54 Mbps; range and speed vary based upon environmental conditions Requires a CEN-WAP-ABG-1G, CEN-WAP-ABG-CM or similar 802.11a/b/g wireless access point and Ethernet enabled Crestron control system (all sold separately) Requires a Cisco [®] controller solution to be installed and commissioned by a Cisco certified technician

(Continued on following page)

TPMC-8X-GA Specifications (Continued)

SPECIFICATION	DETAILS
Wired Communication Ethernet ⁵	10/100 Mbps, auto-switching, auto-negotiating, auto-discovery, full/half duplex, DHCP
USB	USB 2.0 host for mouse, keyboard and USB storage devices
Video Streaming/File Formats	H.264 (MPEG-4 part 10 AVC) ⁶ , MJPEG, plus other formats as supported by Windows Media Player
Audio Features	Built-in microphone and speakers, headphone output, Rava SIP Intercom, Crestron IP Intercom, 60 dB echo cancellation
Streaming/File Formats	As supported by Windows Media Player
Audio Feedback	WAV format, 8 & 16 bit PCM, mono & stereo, 8 – 44.1 kHz sampling rates
Amplification	High efficiency Class D stereo, 2.1 Watts per channel
Battery Internal Battery	Lithium Ion, 7.4 Volt, 2200 mAh, Crestron model TPMC-8X-BTP included
Usage per Charge	~1.5 hours continuous, 9+ hours under normal use with standby/power down activated ⁷
Charging Time	~2 hours (~2.5 - 3 hours when in use)
Power Requirements Power Pack	42 Watts (3.5 Amps @ 12 Volts DC) 100~240 VAC 50/60 Hz power pack included
Default IP ID ⁸	03
Minimum 2-Series Control System Update File ^{9, 10}	Version 3.137 or later
Environmental Operating Temperature	32° to 104°F (0° to 40°C)
Storage Temperature	14° to 140°F (-10° to 60°C)
Humidity	10% to 90% RH (non-condensing)
Heat Dissipation	143 BTU/Hr
Enclosure	Plastic front and metal back, stylus storage slot (stylus included), integral docking station port

(Continued on following page)

TPMC-8X-GA Specifications (Continued)

SPECIFICATION	DETAILS
Dimensions	
Height	8.21 in (209 mm)
Width	9.69 in (246 mm)
Depth	1.13 in (29 mm) 1.67 in (43 mm) with external battery pack (sold separately)
Weight (with internal battery)	2.0 lbs (0.9 kg)
Included Accessories	
TPMC-8X-BTP	Internal Battery Pack
Available Accessories	
CEN-NVS200	Network Video Streamer
CEN-WAP-ABG-1G	Wall Mount 802.11a/b/g Wireless Access Point
CEN-WAP-ABG-CM	Ceiling Mount 802.11a/b/g Wireless Access Point
TPMC-8X-BTPE	External Battery Pack
TPMC-8X-DS	Desktop Docking Station/Charger
TPMC-8X-DSW	Wall Mount Docking Station/Charger
VMK-WIN	TouchPoint Virtual Mouse & Keyboard Software for Windows®

1. Optimum viewing angle for best contrast is 37°.
2. By design, the touch screen will not load dynamic graphics if they are located on a password protected FTP or HTTP server.
3. Refer to Web site or contact Crestron for a current list of compatible devices and embedded applications. To ensure reliable performance, new device drivers and applications are available only from Crestron through firmware updates.
4. The supported VNC viewer is UltraVNC version 1.0.2. Other VNC viewers may work but are not guaranteed.
5. Via optional docking station.
6. Support for H.264 video and Rava SIP Intercom are future features that will be enabled through a future firmware release.
7. External battery pack allows ~3.5 hours continuous, 20+ hours under normal use.
8. Refer to “Identity Code” on page 12 for details.
9. The latest software versions can be obtained from the Crestron Web site. Refer to the NOTE following these footnotes.
10. Crestron 2-Series control systems include the AV2 and PRO2. Consult the latest Crestron Product Catalog for a complete list of 2-Series control systems.

NOTE: Crestron software and any files on the Web site are for authorized Crestron dealers and Crestron Authorized Independent Programmers (CAIPs) only. New users may be required to register to obtain access to certain areas of the site (including the FTP site).

Physical Description

This section provides information on the connections, controls and indicators available on your TPMC-8X-GA.

TPMC-8X-GA Physical View (Shown on Optional TPMC-8X-DS Desktop Docking Station/Charger)



TPMC-8X-GA Overall Dimensions (Shown with Optional TPMC-8X-BTPE External Battery Pack Attached)

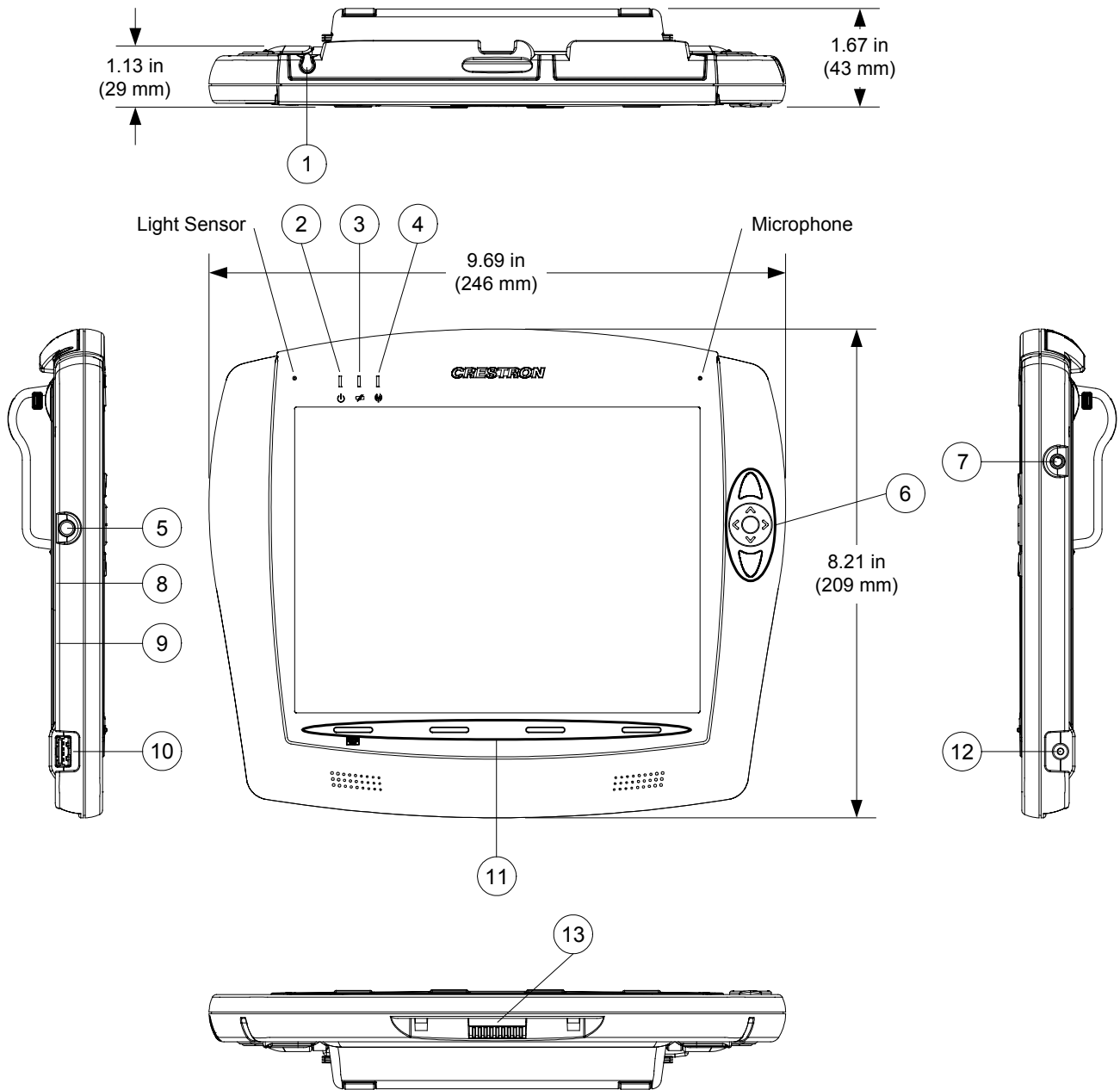



Connectors, Controls & Indicators

#	CONNECTORS, CONTROLS & INDICATORS	DESCRIPTION
1	Stylus	Used to "tap" or to do "select and drag" functions just as you would using a mouse; Also used to "type" on the input screen "keyboard" when entering text or commands
2	Power LED	(1) Green LED, indicates touch screen power status
3	Battery LED	(1) Green/yellow dual color LED, indicates battery condition and charging status; When AC is offline and the external battery is connected, the touch screen will use the external battery before using the internal battery and the LED will remain solid green; Once the internal battery is in use, the LED will remain solid green if battery level is above 25% ($\pm 3\%$) of full charge, solid yellow if charge drops to 25% ($\pm 3\%$) and blinking yellow if battery level drops to 10% ($\pm 3\%$); When AC is online and battery is charging, the LED will be blinking green until charge is 100%, at which time it will light solid green
4	Wi-Fi LED	(1) Green LED, indicates wireless network connection status: Solid green – communicating with a wireless access point (WAP) Blinking green – searching for a WAP Off – no wireless communication (unit is in power down mode or power is off)
5	Power Button	(1) Push button, initiates "Power On" and Power Down": Press to turn touch screen power on; Press again to put touch screen in power down mode; Press to restore full on mode; Press and hold for four seconds to turn power off (The recommended method for shutting down the touch screen is to press the Shut Down button on the setup menu.)
6	Thumbpad & Arrows ¹	(1) programmable 5-way thumbpad (4-way navigation plus center "Enter" button) and (2) programmable up/down push buttons
7	Headphones 	(1) 3.5 mm TRS mini phone jack; Stereo headphone output
8	Memory Card	(1) MMC compatible card slot ² inside battery compartment; Accepts up to 32 GB MMC (not included)
9	Battery Switch	(1) Recessed slide switch inside battery compartment, shuts off battery for long term storage; refer to "Internal Battery Switch" on page 12

(Continued on following page)

Connectors, Controls & Indicators (Continued)

#	CONNECTORS, CONTROLS & INDICATORS	DESCRIPTION										
10	USB 	(1) USB Type A female; USB 2.0 port for keyboard, mouse and storage devices ^{2, 3} <table border="1"> <thead> <tr> <th>PIN</th> <th>DESCRIPTION</th> </tr> </thead> <tbody> <tr> <td>1</td> <td>+5 VDC</td> </tr> <tr> <td>2</td> <td>Data -</td> </tr> <tr> <td>3</td> <td>Data +</td> </tr> <tr> <td>4</td> <td>Ground</td> </tr> </tbody> </table>	PIN	DESCRIPTION	1	+5 VDC	2	Data -	3	Data +	4	Ground
PIN	DESCRIPTION											
1	+5 VDC											
2	Data -											
3	Data +											
4	Ground											
11	Hard Keys	(4) Programmable push buttons below touch screen										
12	12V 3.5A 	(1) 2.5 mm barrel DC power jack; 12 Volt DC power input (power supply included); Power pack can also be used to charge internal battery										
13	Docking Station Connector	Mates with TPMC-8X-DS or TPMC-8X-DSW Docking Station/Charger (sold separately)										

1. For programming details, refer to “Hard Buttons” on page 23.
2. Refer to Web site or contact Creston for a current list of compatible devices and embedded applications. To ensure reliable performance, new device drivers and applications are available only from Creston through firmware updates.
3. Only generic USB devices (i.e., simple keyboard, mouse and external storage) should be used with the TPMC-8X-GA. Any complex USB devices (e.g. a storage device with a built-in fingerprint scanner) will not have the proper support on the touch screen.

Setup

Identity Code

The IP ID is set within the TPMC-8X-GA's table using Crestron Toolbox™. For information on setting an IP table, refer to the Crestron Toolbox help file. The IP IDs of multiple TPMC-8X-GA devices in the same system must be unique.

When setting the IP ID, consider the following:

- The IP ID of each unit must match an IP ID specified in the SIMPL Windows program.
- Each device using IP to communicate with a control system must have a unique IP ID.

Internal Battery Switch

The TPMC-8X-GA comes with a TPMC-8X-BTP Internal Battery Pack installed. To prevent internal battery drain during shipment or long-term storage, the TPMC-8X-GA has a battery switch inside the battery compartment. To use the internal battery, remove the battery compartment cover by first removing the two screws that attach it to the back of the touch screen. Move the switch to the left (ON) position and re-attach the battery compartment cover.

To conserve internal battery power when the unit will not be used for extended periods, move the switch to the right (OFF) position.

NOTE: The internal battery can still be charged with the switch in the OFF position.

TPMC-8X-GA Internal Battery Switch

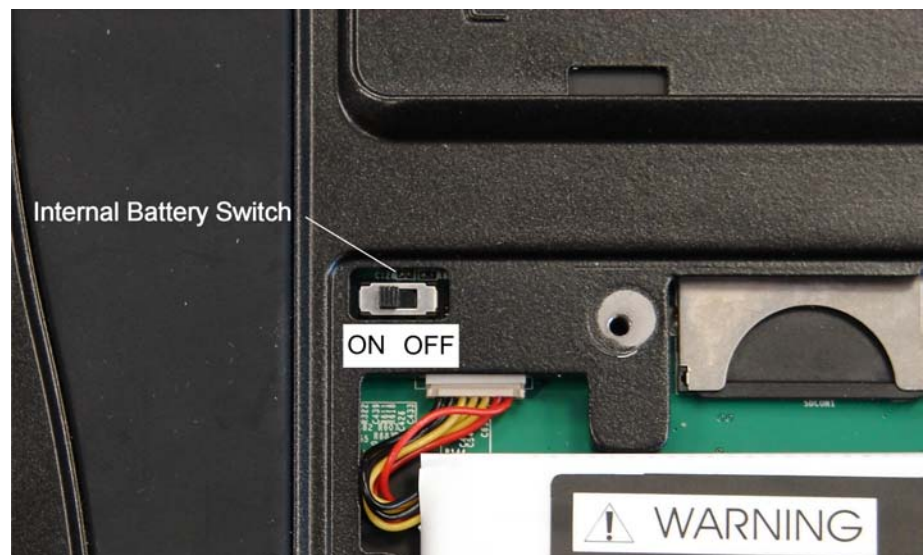

Configuring the Touch Screen

NOTE: The only connection required to configure the touch screen is power (supplied from the internal battery, external battery or the included power pack).

The TPMC-8X-GA is configured from the setup menu.

NOTE: If no project has been loaded or if an invalid project has been loaded, the touch screen displays the startup splash screen.

If a project is running, the setup menu can be accessed using one of three methods.

Via the Hard Keys

Press the four hard keys at the bottom of the touch screen in sequence, from left to right and again from left to right (i.e., press 1, 2, 3, 4, 1, 2, 3, 4) within a 10 second period.

Via USB Keyboard

1. Attach a USB keyboard (refer to “Hardware Hookup” on page 38 for details).
2. Open the “Validate User Account Info” window (shown below) by pressing **Ctrl+Alt+Shift** on the keyboard.

“Validate User Account Info” Window



3. Enter the user account *tpmadmin*, and the password *tpmadmin* and touch **Validate**.

NOTE: The password is case sensitive. After logging in, the password can be changed from the “Security” window. Refer to “Security” which starts on page 15 for more information.

4. When the “Crestron System Manager” window appears (shown below), select **Project | Enter Setup Mode** to enter the setup menu (refer to “Setup Menu Details” which starts on page 15).

“Crestron System Manager” Window



Via Crestron Toolbox

1. Establish communication with the touch screen (refer to “Establishing Communication” on page 47 for details).
2. From the System Info page, select **Functions | Setup Mode...**

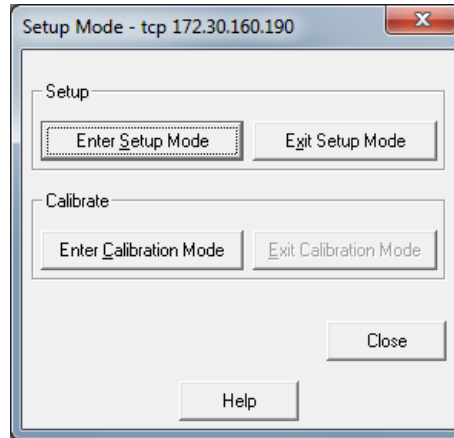
“Setup Mode” Window

3. Select **Enter Setup Mode**. The setup menu will be displayed as shown in the following diagram.

NOTE: Select **Exit Setup Mode** to exit the setup menu.

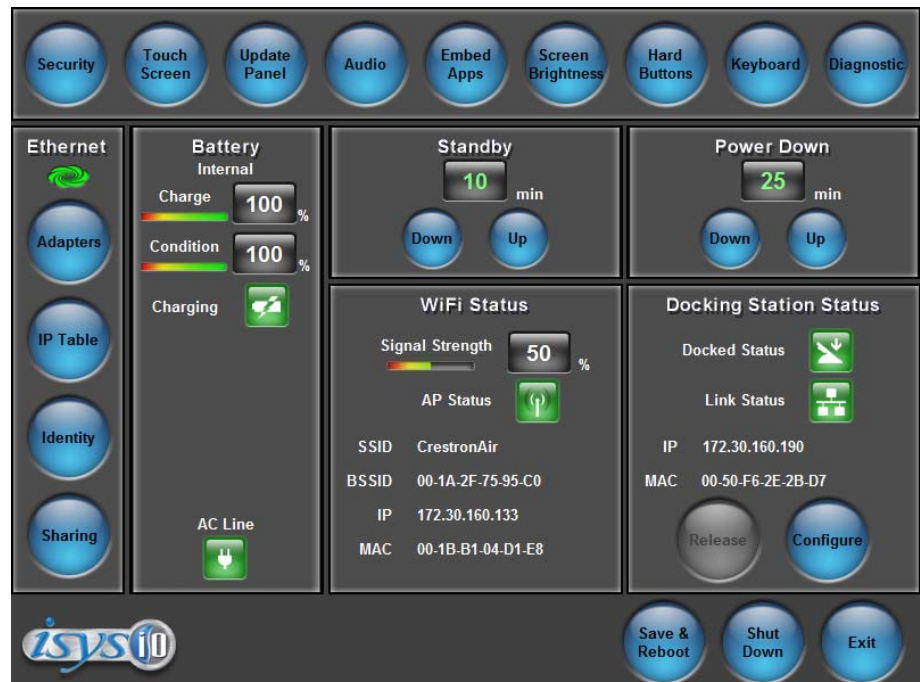
TPMC-8X-GA Setup Menu

NOTE: Another way to enter the setup menu (after a project has been loaded) is to touch the screen during boot up when you see the “Preparing to Load Project” message. Maintain touch until after the countdown, when the message will change to “Loading Setup Screen”.

The setup menu provides access to all basic functions and parameters. It is divided into *Setup*, *Ethernet*, *Battery*, *Standby*, *Power Down*, *WiFi Status* and *Docking Station Status* sections. There are also buttons for **Save & Reboot**, **Shut Down** and **Exit**.

NOTE: To allow the touch screen to upload projects, standby is disabled until approximately five minutes after the project is loaded.

To exit the setup menu and return to the program, touch **Exit**, located at the bottom of the setup menu. To save any changes and reboot the touch screen, touch **Save & Reboot**, located at the bottom of the setup menu. Use the **Shut Down** button to turn off the touch screen.

Setup Menu Details

The setup menu allows configuration of the touch screen's settings for security, touch screen calibration, runtime project, audio, embedded applications, diagnostics and hard button programming. The setup menu also has a button that will toggle the on-screen keyboard on and off.

Security

The **Security** button opens the "Security Setup" window, which allows the user to change the username and password of the system account, setup and close network connections, setup a proxy server and clear Internet browser temporary files, history and cookies.

NOTE: To use the on-screen keyboard for security settings, touch **Keyboard** on the setup menu before touching **Security**.

"Security Setup" Window

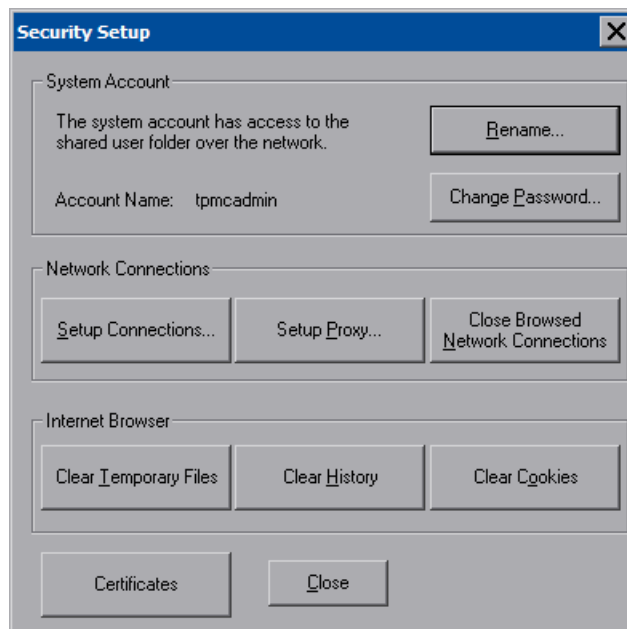

Touch **Setup Connections...** to open the "Network Connections" window. This window is used to map to a network drive. A mapped network drive permits easy access to embedded application files (Word, Excel, PowerPoint, etc.) and provides a

location to save files. To further customize the installation, network drives containing compiled touch screen project files can also be mapped.

“Network Connections” Window

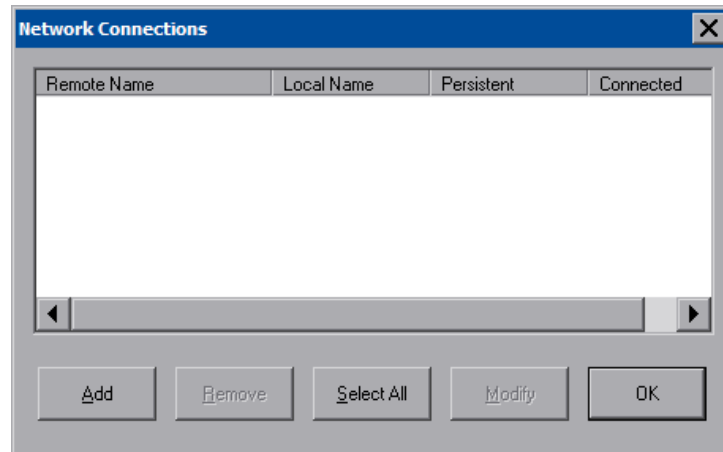

To add a new network connection, touch **Add**.

“Configure Network Connection” Window

Remote Name: ...

Map Drive Letter: ▾

User Name:

Password:

Remember and reconnect on startup.

Buttons: OK, Cancel

To add a network drive, perform the following procedure:

1. Touch to browse for the new network connection. If the remote shareable folder name does not appear on the list, it can be entered manually in the *Remote Name* field, using the following format:

```
\\Remote host name\Shareable folder name
```
2. Map this connection by selecting a drive letter from the *Map Drive Letter* drop box.
3. Enter a User Name and Password.
4. Touch the *Remember and reconnect on startup* checkbox if so desired.
5. Touch **OK** to enable the new network connection and return to the “Network Connections” window.

Once all changes to network connections have been completed, touch **OK** to return to the “Security Setup” window.

The **Certificates** button can be used to install or uninstall certificates used for server and/or user authentication when making a secure connection (for example, to a secured wireless access point). In order to use certificates, the TPMC-8X-GA Security Pack must be installed (refer to “Appendix: TPMC-8X-GA Security Pack” which starts on page 55 for details).

Touch **Close** to return to the setup menu.

Touch Screen

When **Touch Screen** is touched, the calibration screen will be displayed. Touch the screen to begin the calibration process. If the screen is not touched within 10 seconds, the calibration sequence will stop and the screen will again display the setup menu.

If the screen is touched within the 10-second timeout, it displays a series of messages indicating that you should touch the red square in five places around the screen. These messages will appear sequentially starting with “Touch the red square” at the top of the screen toward the upper left corner. Touch and hold the center of the red square to initiate calibration. The message will say “Hold...” for a few seconds, then change to “Lift off to proceed”. Touch the displayed squares as prompted everywhere they appear around the screen until the calibration is complete and you are returned to the setup menu.

NOTE: When touching the screen during calibration, be as accurate as possible. Use the tip of the included stylus. To cancel calibration and return to the setup menu without saving calibration data, ignore the “Touch the red square” message. After about 10 seconds, the setup menu will be displayed. If a USB keyboard is attached to the touch screen, you can also press the Escape key (**Esc**) to cancel calibration and return to the setup menu.

NOTE: The touch screen’s calibration routine can also be accessed through Crestron Toolbox if the touch screen is connected to a control system via TCP/IP. From the System Info page, select **Functions | Setup Mode...** Select **Enter Calibration Mode** to begin calibration.

Update Panel

The **Update Panel** button permits the selection of the touch screen program, a .vtz file. The *Project* tab of the “Project and Firmware” window (refer to illustration on the following page) displays the *Current Loaded Project* and also has a *Load New Project* section.

Current Loaded Project displays the *Name* and *Creation Time* of the current project.

In the *Load New Project* section, touch **Browse** and select the compiled project (i.e., the .vtz file) to be loaded from a network drive, USB device or flash drive. You can choose the location where your uncompressed project files will be stored. The default file location is the internal flash. Touch **Load** to uncompress the project file, place it in the destination selected in *Target Location to Load the Project to* and display it on the touch screen.

NOTE: If there is a mapped network drive on the touch screen, the first time you select **Browse**, it may take some time for the “Open” window to appear.

NOTE: When selecting **Browse**, the contents of the “Recent” folder will not be available.

NOTE: Projects can also be loaded via Crestron Toolbox.

NOTE: If **External** is checked, the display list cannot be viewed via Crestron Toolbox.

“Project and Firmware” Window (Project Tab)

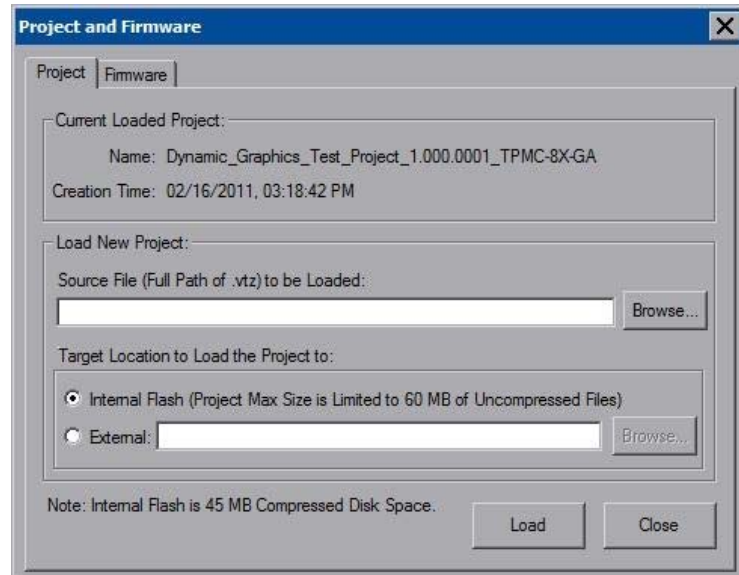

The *Firmware* tab of the “Project and Firmware” window (refer to illustration on the following page) displays the *Current Loaded Firmware* and also has a *Load New Firmware* section.

Current Loaded Firmware displays the *Version* of the current firmware.

In the *Load New Firmware* section, touch **Browse** and select the firmware file (i.e., the .csz file) to be loaded from a network drive, USB device or flash drive. Touch **Load** to load the new firmware.

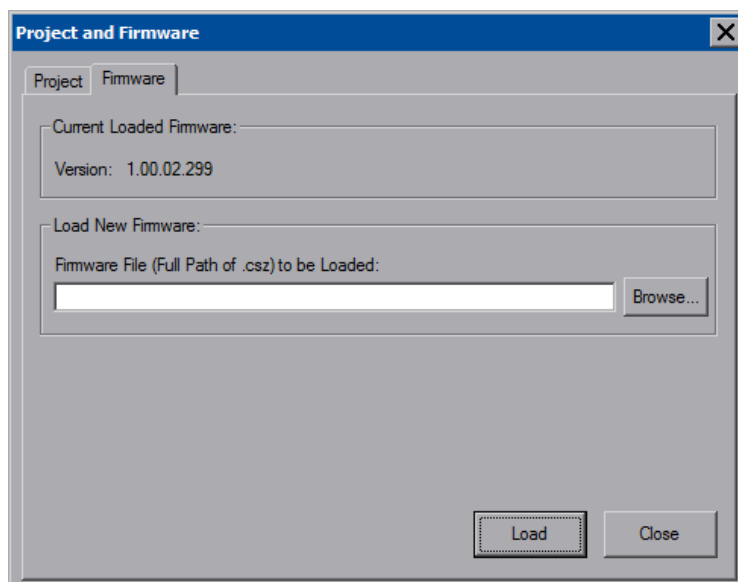
“Project and Firmware” Window (Firmware Tab)**Audio**

The **Audio** button opens the “Audio Setup” window. Volume, balance, and mute controls are available for *All Audio* and *Wave Out*. In addition to volume and mute controls, *Microphone In* includes a *Boost* checkbox, which applies a 20 dB boost to the level of the microphone input. The key click sound can be enabled or disabled with the *Key Click On* and *Off* radio buttons.

When connected to the (optional) TPMC-8X-DSW docking station, the *Audio Output* section of the window provides radio buttons for selection of internal or external speakers. In addition, a checkbox allows for automatic switching to external speakers when docked.

The **Test Recording** button allows testing of the built-in microphone.

Touching **Play Test** plays a short internal audio file. Changes to audio settings are made in real time.

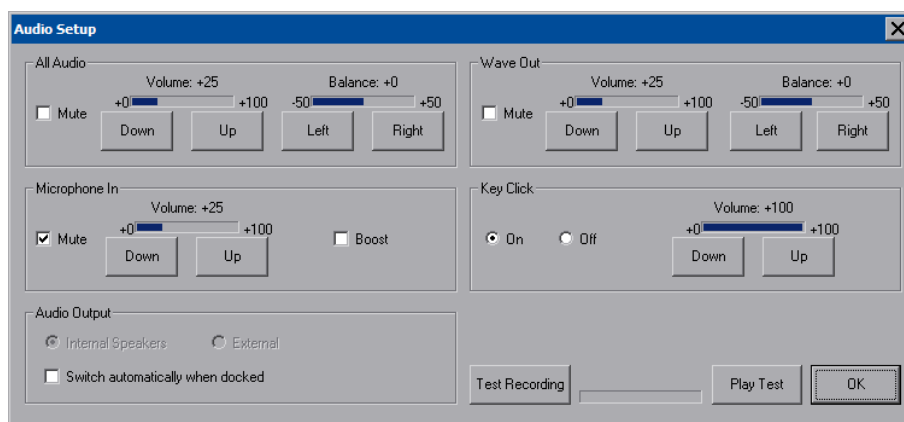
“Audio Setup” Window

Embed Apps (Embedded Applications)

The **Embed Apps** button opens a window that permits you to set Internet security to different levels for different types of Internet sites.

“Embedded Apps” Window

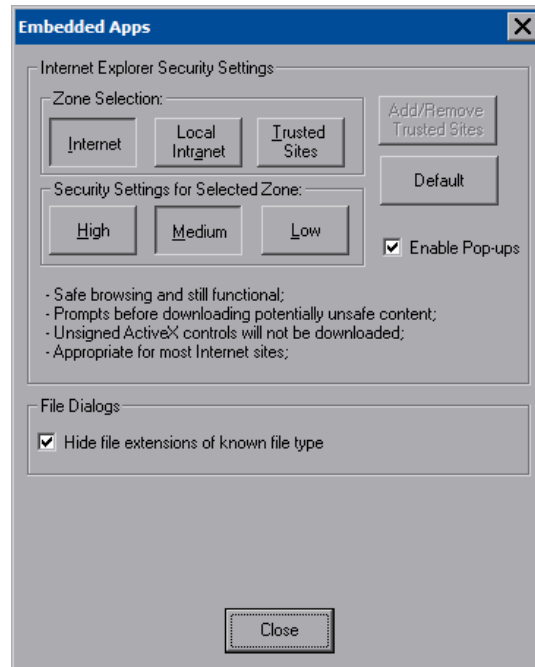

Three security levels (**High**, **Medium** and **Low**) can be selected for each of the three zones (**Internet**, **Local Intranet**, and **Trusted Sites**). The security levels are defined as:

- **High:** The safest way to browse, but also the least functional. Less secure features are disabled. Appropriate for sites that may have harmful content.
- **Medium:** Safe browsing and still functional. Prompts before downloading potentially unsafe content. Unsigned ActiveX controls will not be downloaded. Appropriate for most Internet sites.
- **Low:** Minimal safeguards and warning prompts are provided. Most content is downloaded and run without prompts. All active content can run. Appropriate for sites you absolutely trust.

Touch **Default** to restore the default security settings. By default, security is set to **Medium** for **Internet** and **Local Intranet**, and **Low** for **Trusted Sites**.

The “Embedded Apps” window also permits you to enable the popup windows (child windows) that open when you are in Internet Explorer (not the popup windows of the embedded applications).

NOTE: Refer to the Crestron Web site (www.crestron.com), online help Answer ID 4190, for information on the latest versions of the software.

Touch **Close** after all changes have been made. The touch screen must be rebooted for changes to take effect. Refer to “Save & Reboot and Shut Down Details” on page 37 for more information.

A list of trusted sites can be created and edited by touching **Add/Remove Trusted Sites**. Touching this button will open the “Trusted Sites” window. From here, trusted sites can be added and edited. Sites are listed by domain name or IP address. Once all sites have been entered, touch **Close**.

“Trusted Sites” Window

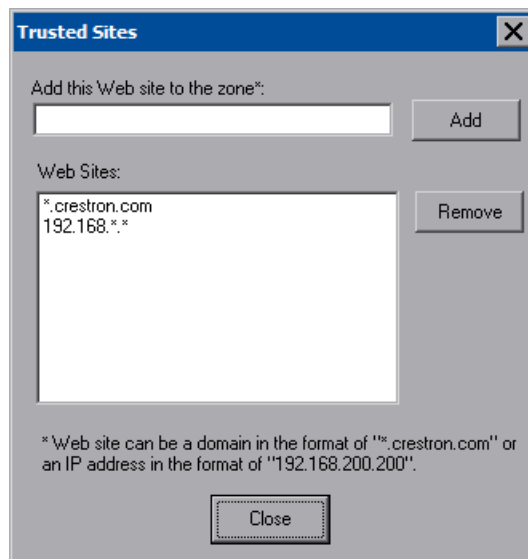

NOTE: Save & Reboot on the setup menu must be selected for Embedded Apps changes to take effect.

NOTE: While browsing the Internet with the TPMC-8X-GA, clicking on a link may cause a message box titled "Restrictions" to appear that contains the text "This operation has been cancelled due to restrictions in effect on this computer. Please contact your system administrator." If this message appears, checking *Enable Popup Windows* in the “Embedded Apps” window may correct this error. Other restrictions may also cause this error, so this may not prevent all occurrences.

NOTE: The TPMC-8X-GA supports automatic connection to the VNC server when the VNC View application is opened. For automatic connection without having to enter the server location and password every time the VNC viewer is opened, launch the application and using a USB mouse, right-click on the VNC viewer window, then select **Save configuration info as...**

NOTE: Refer to the Crestron Web site, online help Answer ID 4627, for information on how to set up the VNC viewer. Refer to Answer ID 3345 for information on how to program the MJPEG viewer. Refer to Answer ID 4640 for information about the default paths for embedded applications and dynamic graphics.

NOTE: Applications that use audio will need to be re-launched when the TPMC-8X-GA is docked or undocked from the (optional) TPMC-8X-DSW docking station, unless it is set to use *Internal Speakers* and *Switch automatically when docked* is unchecked (refer to “Audio” on page 19 for details).

Screen Brightness

Touching **Screen Brightness** will display a screen with **Up** and **Down** controls for *Screen Brightness*, a *Light Sensor* level indicator and **On** and **Off** controls for *Auto Brightness*.

Screen Brightness can be varied from 0 to 100. To increase brightness, touch **Up**. To decrease brightness, touch **Down**. Lower brightness settings extend battery life.

Touch **Close** to return to the setup menu.

Screen Brightness Screen

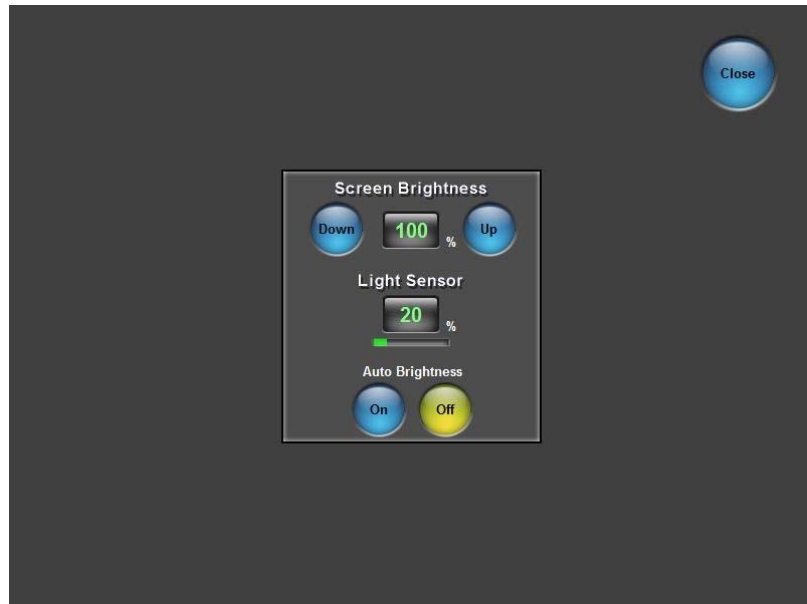

Hard Buttons

Touching **Hard Buttons** will display a screen that provides visual feedback for all button presses. Pressing hard keys 2 through 4, the up or down buttons or any of the buttons on the 5-way thumbpad will result in its corresponding number on the screen illuminating in yellow.

By default, hard key number 1 toggles the on-screen keyboard on and off. However, this can be disabled using the **Keyboard** button on the **Hard Buttons** screen. Hard key number 1 can then be used like any of the other buttons. If disabled, it will use the VT Pro-e[®] project assignment.

By default, hard key number 4 will release the touch screen from the (optional) TPMC-8X-DSW docking station.

Buttons are programmed using VT Pro-e.

Touch **Close** to return to the setup menu.

Hard Buttons Screen



Keyboard

Touch **Keyboard** to display the on-screen keyboard.

The on-screen keyboard can be used in an identical manner to a physically connected keyboard. It can be used in any of the embedded applications, for example, to enter a Web address or to enter data into a spreadsheet, etc.

On-Screen Keyboard



The on-screen keyboard also has a few special keys:

Touch the  key to change to a numeric keyboard, as shown in the illustration that follows.

On-Screen Keyboard - Numeric



Touch the  key to change to a symbol keyboard, as shown in the illustration that follows.

On-Screen Keyboard - Symbols





From either the numeric or the symbol keyboard, touch the  key to return to the alpha keyboard.

The initial position of the on-screen keyboard is determined by the VT Pro-e program or SIMPL Windows settings. The on-screen keyboard will default to its largest size.

In use, when the on-screen keyboard is moved and/or resized and then closed, it will re-open in the same position it was in and at the same size it was when closed. This position and size will remain in memory until the touch screen is re-booted or it is re-set by the SIMPL Windows program. After reboot, the position of the on-screen keyboard will revert to the defaults set in the VT Pro-e or SIMPL Windows program. The size will revert to the largest as determined by the firmware installed in the touch screen.

Exit the on-screen keyboard by selecting by touching the red close button in the upper right corner of the keyboard window. If the **Keyboard** button on the start menu is still visible, you can also touch it to exit the keyboard.

Diagnostic

Touch **Diagnostic** to display the firmware version number, view *Installed Packs* and to reset the end user license from the “Diagnostics” window.

“Diagnostics” Window

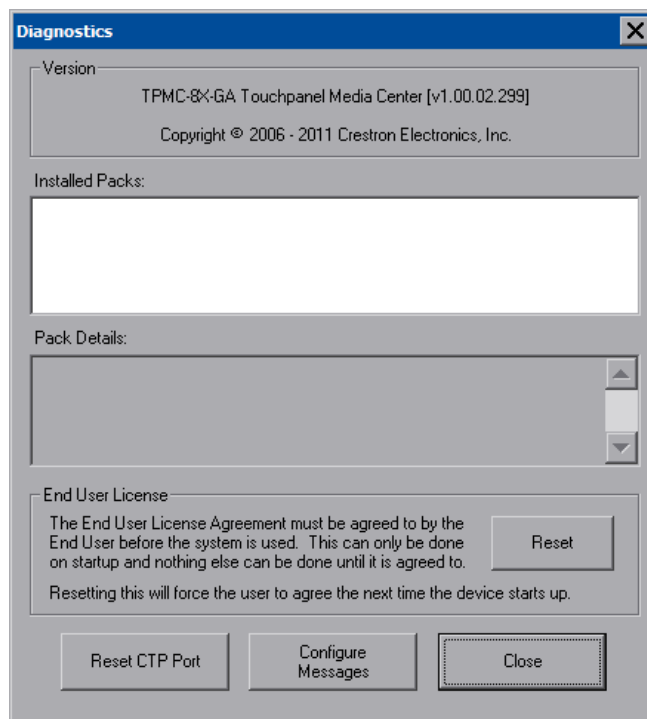

Reset CTP Port resets the default value of the CTP port to 41795, for terminal connection using Crestron Toolbox.

To configure the appearance of popup messages and passcode messages, touch **Configure Messages**. The “Message Configurations Properties” window will open.

“Message Configurations Properties” Window (Popup Messages Tab)

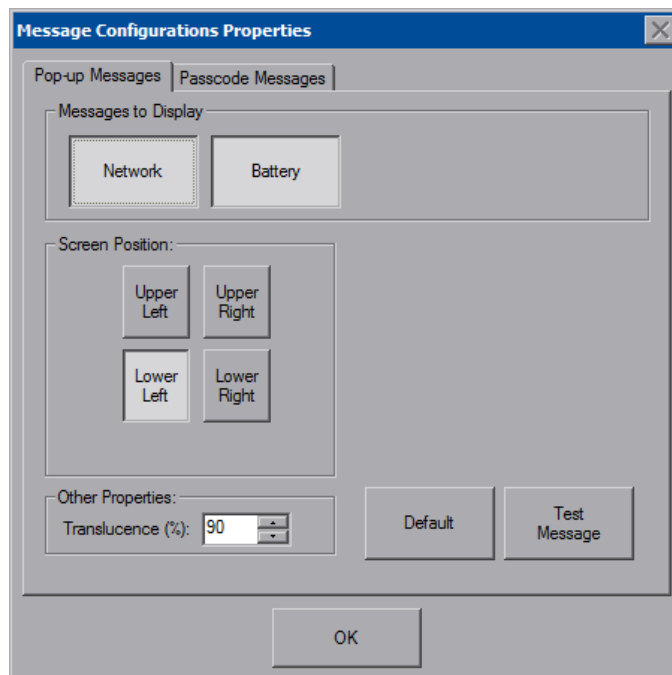

To configure the appearance of popup messages, touch the *Popup Messages* tab.

There are various popup messages. The button associated with each type (**Network** and **Battery**) allows you to set which types are displayed.

There are three types of **Network** popup messages. Following are definitions of each message type:

- **Connected:** A green popup message appears when the touch screen is connected to the control system.
- **Checking Connection:** A yellow popup message appears when the touch screen is experiencing network issues.
- **Disconnected, Trying to Reconnect...:** A red popup message appears when the touch screen loses connection with the control system.

There are three types of **Battery** popup messages. Following are definitions of each message type:

- **Low Battery:** A yellow popup message appears when battery is low.
- **Very Low Battery:** A red popup message appears when battery power is very low.
- **Shutting Down:** A red popup message appears when battery power is not sufficient to supply the touch screen.

A control for popup message *Translucence* is also provided. Translucence ranges from 25% to 100%, with a default value of 90%.

The **Default** button restores the original *Screen Position* and *Translucence* settings, as well as enabling display of *Network* messages. A **Test Message** button lets you see the changes to popup message position and translucence. Touch **Close** to close the popup window.

NOTE: The default value for *Screen Position* is **Lower Left**.

To configure the appearance of passcode messages, touch the *Passcode Messages* tab.

“Message Configurations Properties” Window (Passcode Messages Tab)

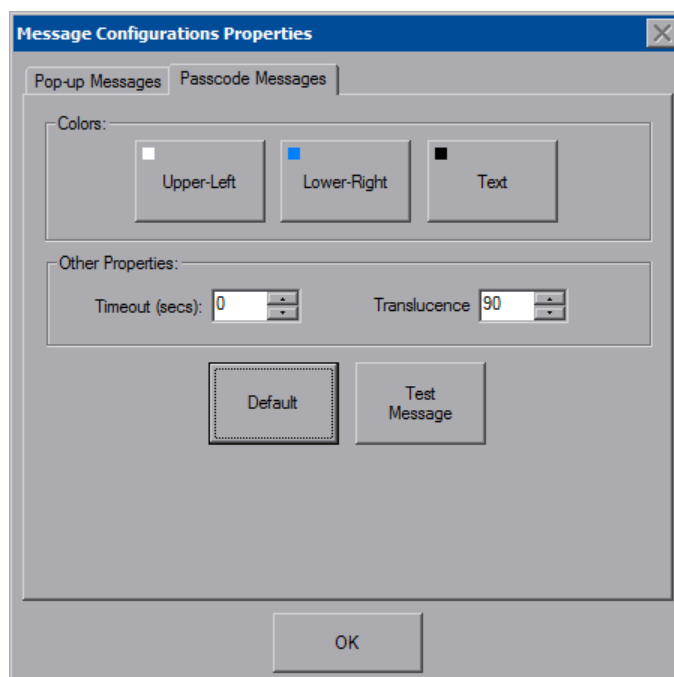

The *Colors* controls allow you to determine background and text color of passcode messages, which will appear when releasing the touch screen from the (optional) TPMC-8X-DSW docking station (refer to “Docking Station Status Details” which starts on page 36 for details).

Also provided are controls for popup message *Timeout* and *Translucence*. Translucence ranges from 25% to 100%, with a default value of 90%.

The **Default** button restores the original *Colors*, *Timeout* and *Translucence* settings and enables passcode messages. A **Test Message** button lets you see the changes to passcode message appearance. Touch **Close** to close the test popup window.

NOTE: The default values for *Color* are white for *Upper Left*, blue for *Lower-Right* and black for *Text*. The default value for *Timeout* is 0 seconds.

Ethernet Details

The Ethernet portion of the setup menu allows configuration of the touch screen settings for Ethernet communications.

The Crestron Swirl logo  at the top of the Ethernet portion of the setup menu illuminates to indicate the status of your connection to the control system(s):

- Green Connected
- Yellow Network trouble
- Orange Connected to some but not all of the control systems (listed in IP table)
- Red Not connected to any control system (listed in the IP table)

NOTE: After configuring Ethernet settings (e.g. changing IP address, etc.), wait at least five seconds after seeing the change in the *WiFi Status* section of the main setup menu before initiating a **Save & Reboot** to save the new settings.

Adapters

Touch **Adapters** to access the “Ethernet Setup” window. To save any changes, use the **Save & Reboot** button on the setup menu. The Ethernet address and mask are displayed on this screen.

“Ethernet Setup” Window

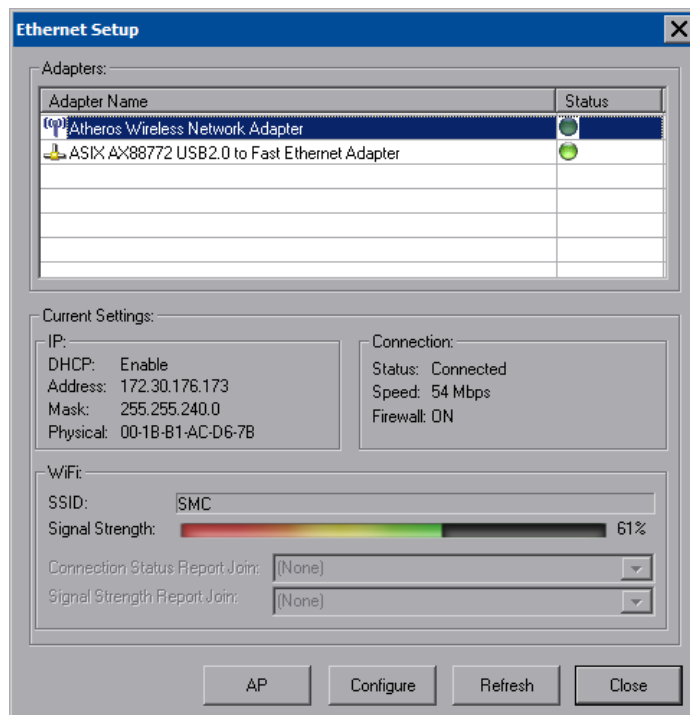

NOTE: The “ASIX AX88772 USB 2.0 to Fast Ethernet Adapter” line in the “Ethernet Setup” window is seen only when the TPMC-8X-GA is mounted on the optional (TPMC-8X-DS or TPMC-8X-DSW) Docking Station/Charger.

NOTE: When the TPMC-8X-GA is mounted on the optional Docking Station/Charger and the wired LAN connection is used, the touch screen auto-switches to wired Ethernet communications. When the TPMC-8X-GA is removed from the Docking Station/Charger, it will seamlessly switch over to Wi-Fi. Docking Station/Charger must be using AC power for its LAN and USB ports to function.

NOTE: Refer to the Crestron Web site (www.crestron.com), online help Answer ID 4628, for information on how Windows® switches between wired Ethernet communications and Wi-Fi.

NOTE: The TPMC-8X-GA Security Pack allows the user to provide a username and password for authentication in infrastructures utilizing a RADIUS (Remote Authentication Dial In User Service) server. For details, refer to “Appendix: TPMC-8X-GA Security Pack” which starts on page 55.

Configure the Wireless Network

NOTE: In most cases, the built in Windows functionality will allow configuration of the wireless network. If advanced authentication is required, the TPMC-8X-GA Security Pack (version 1.4 or later) must be installed (refer to “Appendix: TPMC-8X-GA Security Pack” which starts on page 55). When the Security Pack is installed, the **AP** button will appear in the “Ethernet Setup” window (refer to illustration on page 28) and the configuration procedure outlined in the appendix must be used to configure the wireless network; the procedure outlined below will no longer work.

From the “Ethernet Setup” window (refer to illustration on page 28), select the wireless adapter and touch **Configure** to open the “Wireless Network Connection Properties” window. This window displays the connection and related required items.

Touch the *Wireless Networks* tab.

“Wireless Network Connection Properties” Window (Wireless Networks)

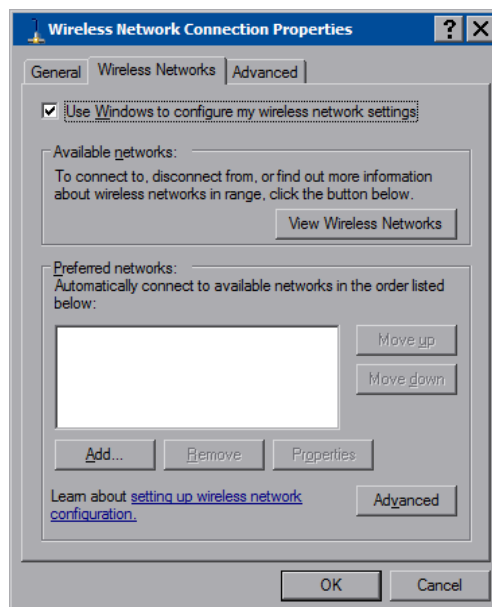

NOTE: In order to configure the wireless network using the following procedures, make sure the *Use Window to configure my wireless network settings* checkbox is checked. If using the TPMC-8X-GA Security Pack, make sure this is not checked.

NOTE: The link at the bottom of the window, which says “Learn about setting up a wireless network configuration” is not supported at this time.

There are two ways to configure the wireless network: via the wizard and manually.

Configure via the Wizard

To configure your wireless network using the *Wireless Network Setup Wizard*, complete the following procedure:

1. From the *Wireless Networks* tab, touch **View Wireless Networks** to view the “Wireless Network Connection” window.

“Wireless Network Connection” Window

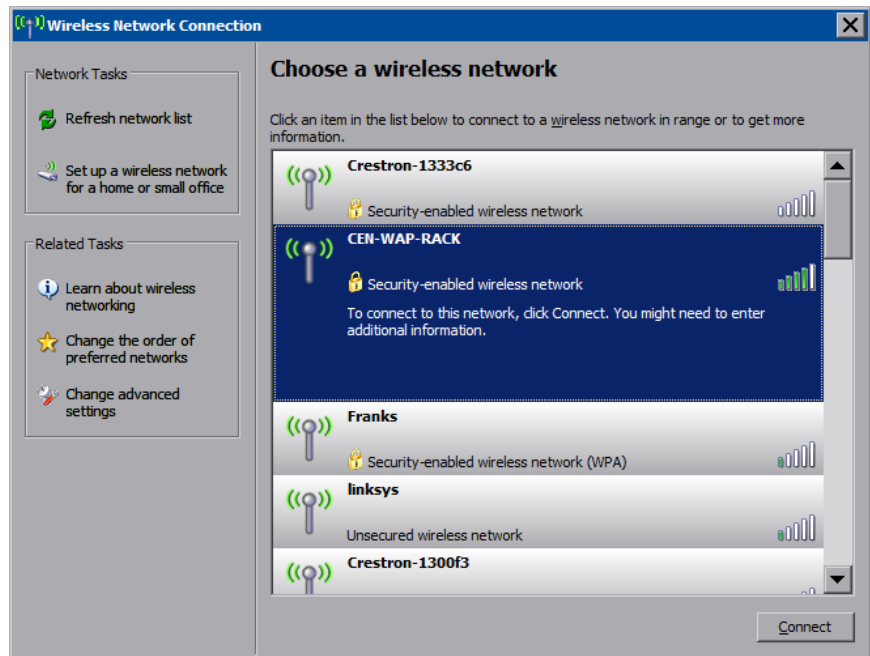

2. Touch **Refresh network list** to scan for available access points.

NOTE: Depending on network settings, the “Wireless Network Connection” window may not show any networks. In this case, configure the network manually. (Refer to “Configure Manually” on page 31.)

3. Select the desired network and touch **Connect** to open the second “Wireless Network Connection” window.

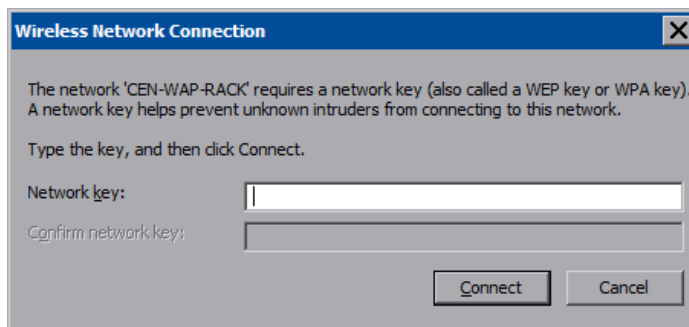
Second “Wireless Network Connection” Window

4. Enter the *Network key* and confirm the network key by entering it a second time when the *Confirm network key* field becomes enabled.
5. Touch **Connect**.

NOTE: The *Wireless Network Setup Wizard* will create a network with the *Network Authentication* value set to **Open** and *Data Encryption* set to **WEP**. If your Wireless Access Point is configured with values other than **Open** and **WEP**, you must set these values manually, using the *Wireless Networks* tab of the “Wireless Network Connection Properties” window (refer to illustration below).

Configure Manually

To configure your wireless network manually, complete the following procedure:

1. From the *Wireless Networks* tab, touch **Add...** to open the “Wireless network properties” window.

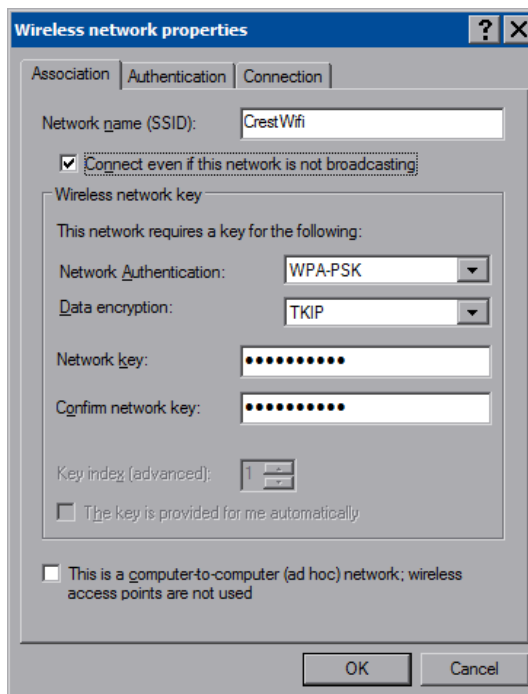
“Wireless network properties” Window

2. Enter the *Network name (SSID)*.

3. Select the *Network Authentication* and *Data encryption* from the dropdown lists.
4. Enter and confirm the *Network key*.
5. Touch **OK**.

After the wireless network has been configured, either by the wizard or manually, the network name will appear in the *Preferred networks* box in the “Wireless Network Connection Properties” window (refer to illustration on page 29). To delete a network from the list, select the network, then touch **Remove**.

Configure IP Settings

The procedure for configuring IP settings for both wired and wireless networks is the same. The TPMC-8X-GA is configured for DHCP by default. To establish static processing or to switch between DHCP and static IP, use the *General* tab of the “Wireless Network Connection Properties” window (refer to illustration below), select **Internet Protocol (TCP/IP)** and touch **Properties**.

“Wireless Network Connection Properties” Window (General)

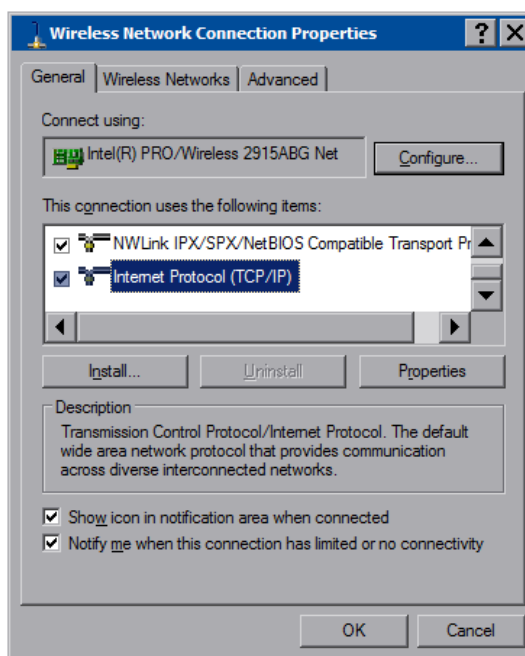

NOTE:
The *Advanced* tab is not supported at this time.

The “Internet Protocol (TCP/IP) Properties” window will open.

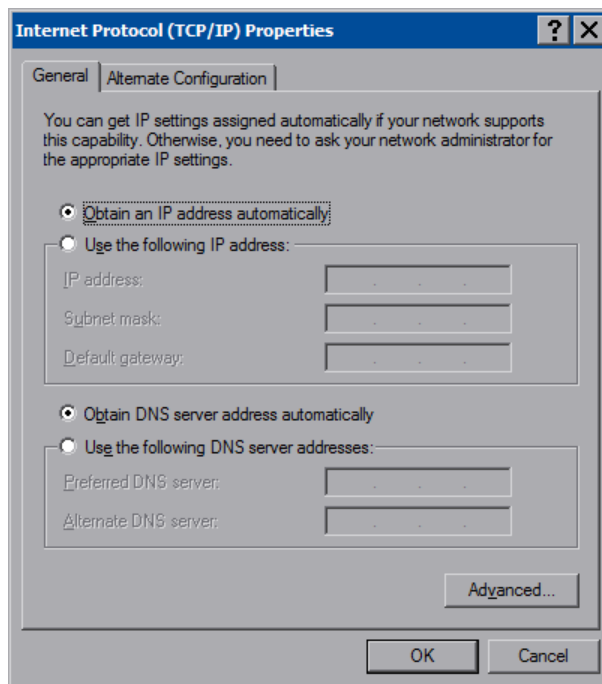
“Internet Protocol (TCP/IP) Properties” Window

Transmission Control Protocol/Internet Protocol (TCP/IP) is a set of protocols that defines how to transfer data between two computers. TCP monitors and ensures correct transfer of data. IP receives the data from TCP, breaks it up into packets, and ships it off to a network. The IP address is a unique number consisting of four parts separated by dots, e.g., 165.113.245.2.

Dynamic Host Configuration Protocol (DHCP) is a protocol for assigning dynamic IP addresses to devices on a network. With dynamic addressing, a device can have a different IP address every time it connects to the network. In some systems, the IP address of the device can even change while it is still connected. DHCP also supports a mix of static and dynamic IP addresses.

Dynamic addressing simplifies network administration because the software keeps track of IP addresses rather than requiring an administrator to manage the task. New computers can be added to a network without manually assigning each one a unique IP address.

NOTE: When configuring an adapter, only one item can be modified at a time. For example, to modify an IP address and also the wireless network, touch **Configure** and modify the IP address, then touch **OK** (you must return to the “Ethernet Setup” window). Touch **Configure** again, modify the wireless network, then touch **OK**. The order in which modifications are performed does not matter.

IP Table

Touch **IP Table** on the setup menu to open the “IP Table Setup” window.

Edit, remove or enter a control system’s IP address in the IP table to enable communication between the touch screen and a control system. The touch screen can communicate with multiple control systems.

For more information on IP tables, refer to the latest version of the Crestron 2-Series Control Systems Reference Guide (Doc. 6256), which is available from the Crestron Web site (www.crestron.com/manuals).

“IP Table Setup” Window

IP ID	Address	Dev ID	Port
04	192.168.194.92		41794

IP Settings

IP ID: IP Address or Hostname: Dev ID (JNR) * Port * :

* Entries are optional and if not specified, the default will be used.

The IP ID is the ID number that is used to identify the touch screen in the control system’s IP table. The IP ID should match the IP ID set in the SIMPL Windows program.

Identity

Touch **Identity** to open the “Network ID” window. The “Network ID” window displays the hostname and workgroup that identify the touch screen on the network. The hostname may be used when transferring a program over Ethernet using Crestron Toolbox. This window permits editing of the hostname and workgroup.

“Network ID” Window

Network ID

Hostname:

Workgroup:

These settings will not take effect until you commit and reboot.

NOTE: The hostname is required for Ethernet communication.

Sharing

Touch **Sharing** to open the “Configure Shared Folders” window. This window is used to set up shared folders. Sharing enables remote computers to view and/or modify files stored on the touch screen.

“Configure Shared Folders” Window

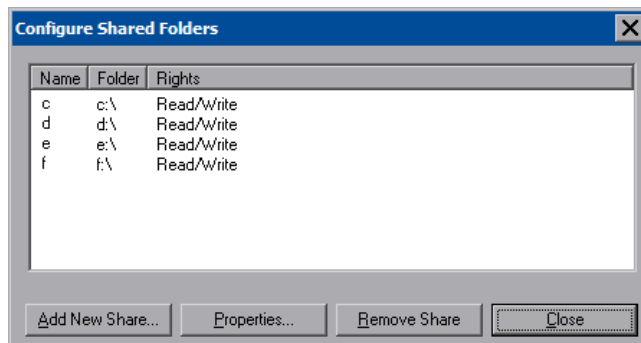

Touch **Add New Share...** to browse and add directories with permission to read only or read/write. Touch **Close** after adding all folders to be shared.

NOTE: For security reasons, there is no persistence of the shared drive(s) after the touch screen is rebooted.

Battery Details

The *Battery* section of the setup menu contains bar graphs showing the amount of charge in the internal battery and the battery condition, as well as indicators to show when the battery is charging and when the TPMC-8X-GA is connected to an AC line.

Standby Details

The *Standby* function turns off the backlight when the touch screen is inactive for a specified time. Use the **Up** and **Down** buttons to set the *Standby* from 0 through 120 minutes, where 0 disables the timeout. Touch the screen to reactivate the touch screen from standby mode. When the touch screen is reactivated, the last screen to be displayed reappears.

NOTE: The hard buttons will still function when the touch screen is in standby mode but will not cause it to awaken from standby. You must touch the screen to reactivate the touch screen.

Power Down Details

The *Power Down* function turns off the touch screen display, shuts off Wi-Fi and puts the processor to “sleep” when the touch screen is inactive for a specified time. Use the **Up** and **Down** buttons to set the *Power Down* from 0 through 120 minutes, where 0 disables the timeout.

The power button (on the left side of the TPMC-8X-GA) can also be used to manually put the touch screen into power down mode. Press and release the power button to enter power down mode. Use the power button to activate the touch screen from power down mode. When the touch screen is activated, the first page of the project appears.

NOTE: When the touch screen is powered down, it will take less than 10 seconds to power up and respond to a button press. There is no delay from Standby mode.

NOTE: If the external AC power pack is attached to the touch screen and plugged into an active AC receptacle or if the touch screen is resting in the docking station and plugged into an active AC receptacle, the touch screen does not power down when the *Power Down* is achieved. Note that the purpose of this timeout is to maximize battery life. *Standby* still functions.

WiFi Status Details

The *WiFi Status* section of the setup menu contains a bar graph showing the strength of the Wi-Fi signal as well as an indicator to show when the TPMC-8X-GA is communicating with a wireless access point (AP). SSID, BSSID, IP and MAC addresses are also shown.

Docking Station Status Details

The *Docking Station Status* section of the setup menu has two indicators: *Docked Status* shows when the touch screen is mounted in a docking station and *Link Status* shows when it is connected to Ethernet via the docking station. IP and MAC addresses are also shown.

The **Release** button can be used to release the TPMC-8X-GA from the docking station. The **Configure** button will open the “Wallmount Docking Station Setup” window.

“Wallmount Docking Station Setup” Window

The screenshot shows the "Wallmount Docking Station Setup" dialog box. It features a blue header with the title. On the left, the "Lock-Down Mode" is selected with a radio button. Below it, text states "The panel can only be removed by authorized users." There is a checkbox for "Show Plain-Text Passcode Dialog" which is unchecked. A group box labeled "Passcodes" contains five empty text input fields. Below these is a label "SIMPL Passcode is NOT set" and a note: "Note: Passcodes are case-sensitive." On the right, the "Standard Mode" is selected with a radio button. Below it, text states "The panel can be removed by anyone." At the bottom right, a "Walldock Release" section contains two checked checkboxes: "Show Pop-up Release Icon" and "Hardbutton #4 Releases Panel". At the bottom center are "OK" and "Cancel" buttons.

In *Standard Mode*, the touch screen to be removed from the docking station by anyone. In *Lock-Down Mode*, only authorized users can remove the touch screen from the docking station by first entering a passcode. The “Wallmount Docking Station Setup” window allows the entry of up to five passcodes. (A sixth passcode, created with the SIMPL Windows program, can be stored in the control system.)

NOTE: If a new SIMPL program is loaded in the control system, the passcode in the previous program can be cleared by rebooting the touch screen.

The *Show Plain-Text Passcode Dialog* checkbox will cause the entered text to appear instead of asterisks, when a passcode is entered.

In addition, the *Show Pop-up Release Icon* checkbox makes a release icon available when a project is views on the touch screen.

Release Icon



The *Hardbutton #4 Releases Panel* checkbox can be used to enable or disable button #4 from releasing the touch screen from the docking station.

Save & Reboot and Shut Down Details

To save any changes and reboot the touch screen, touch **Save & Reboot**, located in the lower right section of the setup menu.

To turn off the touch screen, touch **Shut Down**, located in the lower right section of the setup menu. This is the recommended method for shutting down the touch screen. After the touch screen has shut down, the power supply can be safely removed from the touch screen.

Exit Details

Touch **Exit** to leave the setup menu and return to the project. If no project has been loaded, the touch screen will display an error message and return to the setup menu.

Hardware Hookup

Ventilation

The TPMC-8X-GA should be used in a well-ventilated area.

To prevent overheating, do not operate this product in an area that exceeds the environmental temperature range listed in the table of specifications.

Connect the Device

When making connections to the TPMC-8X-GA, consider the following:

- Use the included Crestron power supply for these devices.
- The power supply cable cannot be extended.

Hardware Connections for the TPMC-8X-GA (Left, Right and Bottom Views)

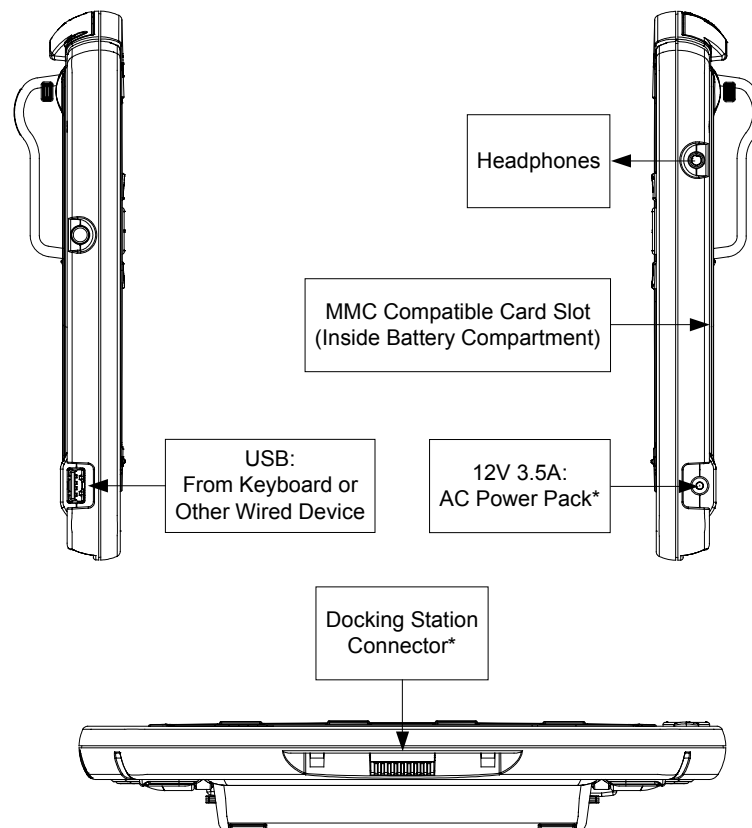

* These connectors are optional for powering the device.

CAUTION: Do not apply excessive pressure to the touch screen display during handling. Doing so can crack the screen and damage the touch screen.

Recommended Cleaning

Keep the surface of the touch screen free of dirt, dust or other materials that could degrade optical properties. Long-term contact with abrasive materials can scratch the surface, which may detrimentally affect image quality.

For best cleaning results, use a clean, damp, non-abrasive cloth with any commercially available non-ammonia glass cleaner. Bezels may not provide a complete watertight seal. Therefore, apply cleaning solution to the cloth rather than the surface of the touch screen. Wipe touch screen clean and avoid getting moisture beneath the bezels.

Programming Software

Have a question or comment about Crestron software?

Answers to frequently asked questions (FAQs) can be viewed in the Online Help section of the Crestron Web site. To post a question or view questions you have submitted to Crestron's True Blue Support, log in at <http://support.crestron.com>. First-time users will need to establish a user account.

Earliest Version Software Requirements for the PC

NOTE: Crestron recommends that you use the latest software to take advantage of the most recently released features. The latest software is available from the Crestron Web site (www.crestron.com/software).

Crestron has developed an assortment of Windows-based software tools to support a customized system. Use SystemBuilder™ or SIMPL Windows to create a program to control the TPMC-8X-GA.

Programming with SystemBuilder

SystemBuilder is a comprehensive programming environment. Appropriate for most systems, it can quickly and easily generate a complete working program including both control processor logic and touch screen graphics.

Programming with SIMPL Windows

NOTE: While SIMPL Windows can be used to program the TPMC-8X-GA, it is recommended to use SystemBuilder for configuring a system.

SIMPL Windows is Crestron's premier software for programming Crestron control systems. It is organized into two separate but equally important "Managers": Configuration and Program.

Configuration Manager

Configuration Manager is the view where programmers "build" a Crestron control system by selecting hardware from the *Device Library*.

1. To incorporate the TPMC-8X-GA into the system, drag the TPMC-8X-GA from the Touchpanels | Touchpanels (Ethernet) folder of the *Device Library* and drop it in the *System Views*.

Locating the TPMC-8X-GA in the Device Library

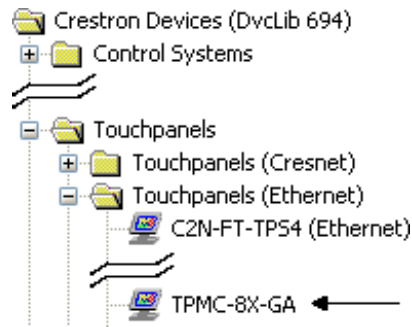

The system tree of the control system displays the device in the appropriate slot with a default IP ID as shown in the following illustration.

C2ENET-2 Device, Slot 8

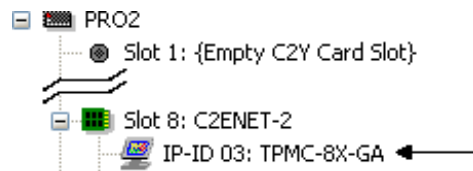

2. If additional TPMC-8X-GA devices are to be added, repeat step 1 for each device. Each TPMC-8X-GA is assigned a different IP ID number as it is added.
3. If necessary, double click a device to open the “Device Settings” window and change the IP ID, as shown in the following illustration.

“TPMC-8X-GA Device Settings” Window

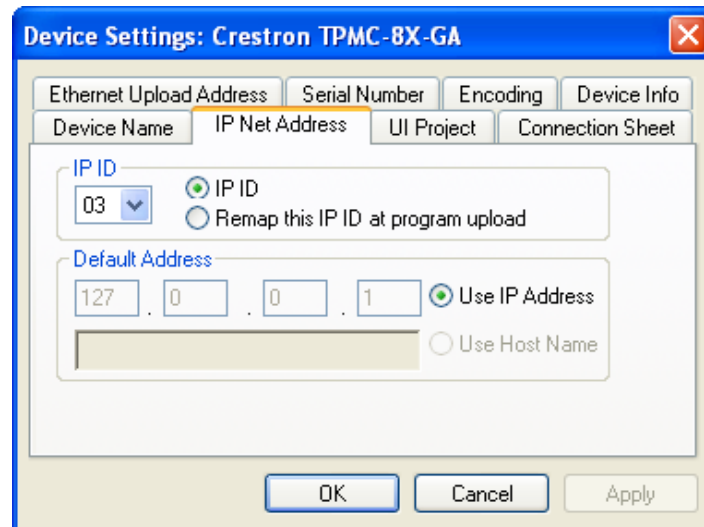

NOTE: The ID code specified in the SIMPL Windows program must match the IP ID of each unit.

Program Manager

Program Manager is the view where programmers “program” a Crestron control system by assigning signals to symbols.

The symbol can be viewed by double clicking on the icon or dragging it into *Detail View*. Each signal in the symbol is described in the SIMPL Windows help file (F1).

Programming with VisionTools Pro-e

Touch screen pages should be created in Crestron VisionTools® (VT Pro-e) to allow accessing the embedded applications, switching of source signals to desired outputs as well as selection of the system mode. There are no special programming requirements to use the functions of the TPMC-8X-GA in a room-control system.

Multi-Mode Objects

Multi-mode objects offer high-performance programming!

The single most-advanced VT Pro-e high-performance programming technique involving the TPMC-8X-GA is the concept of multi-mode objects. A multi-mode object (i.e., button, legend, etc.) is an object drawn on a VT Pro-e page that can have one or more active and inactive visible settings (*modes*).

For examples, refer to www.crestron.com/exampleprograms and search for multi-mode object examples. This file contains the VT Pro-e touch screen files and SIMPL Windows files that illustrate the high-performance capabilities of multi-mode objects.

WAV File Audio Messages

The TPMC-8X-GA touch screens are capable of playing audio messages as system prompts and responses. These files are recorded as WAV files on a PC using an audio utility such as Sound Recorder that is packaged with Microsoft Windows. Files from other sources may also be converted to an acceptable format by using this or a similar utility. Many other audio utilities are available commercially or as shareware. The TPMC-8X-GA touch screens accept the following WAV file formats: **PCM, 8 & 16 bit, 8 – 44.1 kHz, mono & stereo**. For more information about how to use Sound Recorder, refer to its User’s Guide and extensive help information provided with the software. Also, refer to the help file in VT Pro-e to learn how to use its audio tool, Sound Manager, to attach WAV files to a touch screen project.

Pre-recorded WAV files for voice prompts and responses are available from Crestron. These files can be stored into and programmed for use in the touch screen directly or may be edited with the Sound Recorder. For example, the individual files can be combined to create custom messages.

NOTE: Touch screen WAV files can be obtained from the Wave LC Library of the Crestron FTP site.

Bit Depth and File Size

A balance of performance and quality can be achieved by using VT Pro-e to configure the size of graphics in a project. Read this section to learn about bit depth and how to maximize the quality and performance of a TPMC-8X-GA project.

Bit depth refers to the number of memory bits used to store color data for each pixel in a raster image. A touch screen raster image consists of a rectangular grid of picture elements (pixels). Each pixel uses the same amount of memory to store its color data. The amount of memory is called the bit depth of the image.

Greater bit depths are required to represent finer gradations of color. Increasing bit depth necessarily increases file size. A black and white drawing requires only one bit

per pixel to store all the available color information. Using a 32-bit per pixel bit depth for a black and white image increases the file size 32 times without adding anything to the black and white image quality.

In an 8-bit per pixel system, the associated 8-bits of video memory for every screen pixel contain a value referring to a location in an 8-bit color table. In this way, any one of the specific 256 color table locations is assigned to a pixel.

A 16-bit highcolor system is considered sufficient to provide life-like colors. It is encoded using 5-bits to represent red, 5-bits to represent blue and (since the human eye is more sensitive to the color green) 6-bits to represent 64 levels of green. These can therefore be combined to provide 65,536 mixed colors ($32 \times 32 \times 64 = 65,536$).

In a 24-bit graphics display, the video memory allocates 24 bits for each pixel on the screen enabling each pixel to take on any one of a possible 16.7 million colors. Each 24-bit value is composed of 8-bits for red, 8-bits for green and 8-bits for blue. These triplets of 8-bit values are also referred to as the red, green and blue color planes. A 24-bit image is actually composed of three component images which combine to create the truecolor picture. The reason this is called truecolor is that this is near the maximum number of colors the human eye is able to detect.

Truecolor images are sometimes represented by a 32-bit value. The extra 8-bits do not enhance the precision of the color representation but act as an alpha channel that represents pixel translucence. The 32-bit truecolor has become popular on the computer desktop to provide effects such as translucent windows, fading menus and shadows.

In graphics intensive applications such as touch screens, raising or lowering the color depth of the displayed graphics can achieve a balance of performance and quality. Lower color depths do not require as much frame buffer memory or display bandwidth, allowing them to be generated and displayed more quickly. Increasing color depth results in higher color quality at the expense of display speed and responsiveness. By using mostly 8-bit or 16-bit graphics and holding 32-bit graphics to a minimum (e.g. for a family photo, etc.), you can create a sophisticated project that will fit in the memory space provided and have the touch screen remain very responsive.

Relationship of Bits to Colors

NUMBER OF BITS	NUMBER OF COLORS
1 bit	Black and White
2 bits	4 Colors
4 bits	16 Colors
8 bits	256 Colors
16 bits	65,536 Colors (Highcolor)
24 bits	16.7 million Colors (Truecolor)
32 bits	16.7 million Colors plus Transparency

When creating a VT Pro-e project you can elect to compress and reduce the image size in the "Page Properties" window for the entire page and/or perform the same function of reducing the image size using the "Image Properties" window. A reduction in image size will save a considerable amount of memory space for your project.

In VT Pro-e, the **Compress** checkbox permits the image to be compressed when compiling. The **16 Bits** checkbox converts a 24-bit or 32-bit image to 16 bits. This conversion to a 16-bit image may cause the loss of some subtle shading. To compensate for this, use the dithering to simulate the original shading. Check your

image with each of the available dithering types to determine which will deliver the best quality image.

Dithering type selection can be accessed from the “Page Properties” or “Image Properties” windows in VT-Pro-e. Refer to the following illustrations.

**VT Pro-e “Page Properties” Dialog Box
– Bit Depth Selection**

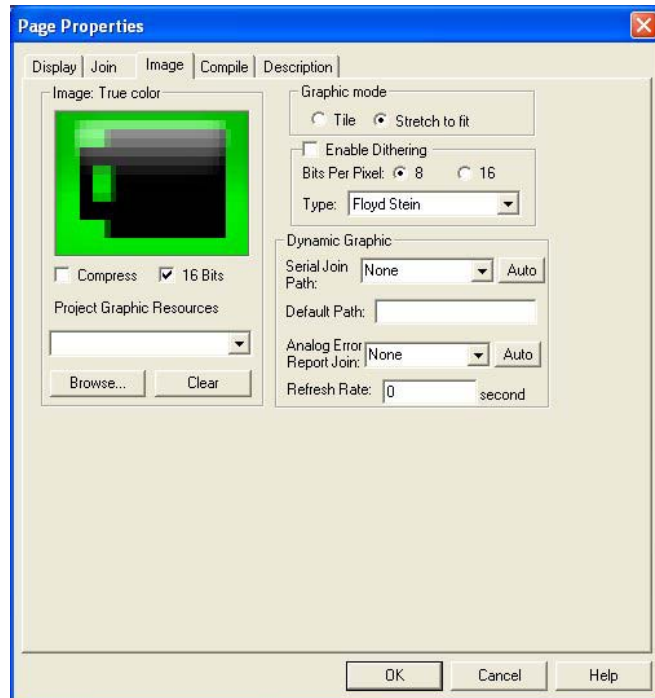

**VT Pro-e “Image Properties” Dialog Box
– Bit Depth Selection**

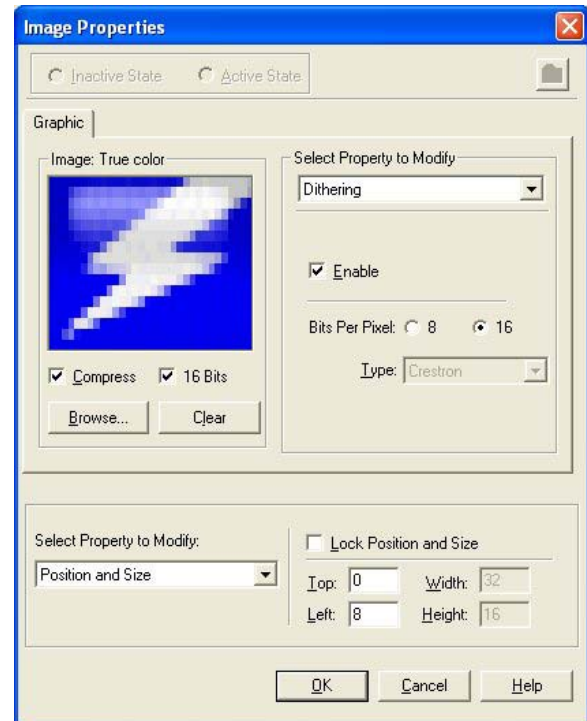

MultiByte International Characters

Most languages use a single byte of eight bits to represent a character, e.g. English, French, German, Hebrew, Russian, Thai, etc.

Multibyte character fonts require more than the usual eight bits to specify a character. This occurs when a language has more than 256 characters (2^8) in a font. For example, Chinese fonts contain several thousand characters. Other multibyte languages include Japanese and Korean.

There are two separate applications with multibyte characters – static text on buttons and indirect text on buttons. No touch screen firmware changes are required in either case.

Indirect text on a button is entered in VT Pro-e and the actual string to be displayed is entered in SIMPL Windows. As of this publication date only completely single byte or completely multibyte strings may be entered or they will not be compiled correctly in SIMPL Windows. In other words, you cannot enter Chinese characters interspersed with numbers. You can enter Chinese characters or numbers in separate strings or you can pad each number with “\x00” to make it multibyte and then combine it with Chinese characters in the same string.

Of course you can always use the workaround of showing a graphic that displays the string but it is not dynamic. To compile and use multibyte characters it is essential that the operating system understand the language. Some versions of Windows are available in many international languages and add-on software is available for other versions.

Embedded Applications

A number of third-party or in-house applications are embedded in a VT Pro-e TPMC-8X-GA project. (Refer to illustration on the following page.)

- Adobe Reader
- Microsoft Excel Viewer
- Microsoft Internet Explorer
- Microsoft Word Viewer
- MJPEG Viewer
- PowerPoint Viewer
- Remote Desktop
- VNC Viewer
- Windows Media Player
- WordPad

The embedded applications have the following features:

- All embedded applications listed in the VT Pro-e *ProjectView* workspace are created by default for a new TPMC-8X-GA project.
- All applications are created at project-level – one instance per project.
- The static position and size of each application can be viewed from any page.
- Four analog joins can be assigned to each application to dynamically change position and size.
- One digital feedback join or one analog join can be assigned to dynamically show/hide an application.

Embedded Applications in ProjectView

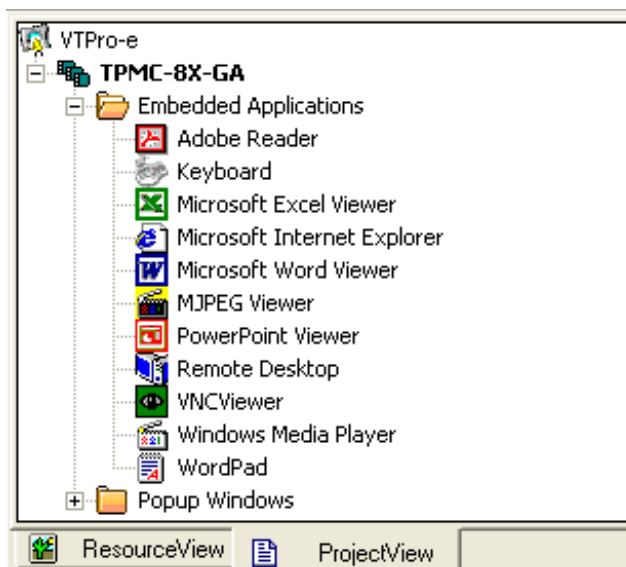

Right-click on any of the applications in the *Project View* and select **Properties** to open the “Embedded Application Property” window (refer to the illustration below). This window permits a choice of positions on the screen, assignment of an analog touch join type and number and a show/hide join number.

Defaults for Embedded Windows Applications

Use the *Default Path* text box in the “Embedded Applications Properties” window to enter the default document for the application.

Edit the *Default Position and Size* in the “Embedded Application Properties” window to point to your new location.

Sample of an “Embedded Application Properties” Window

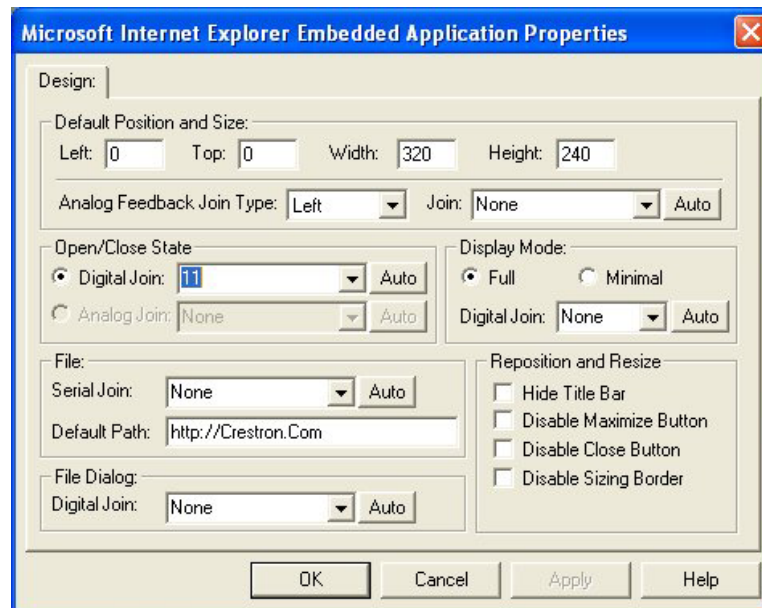

Programming Embedded Windows Applications

The following diagram is an example of a basic SIMPL program that enables you to open/close an embedded application. The example program is discussed following the diagram.

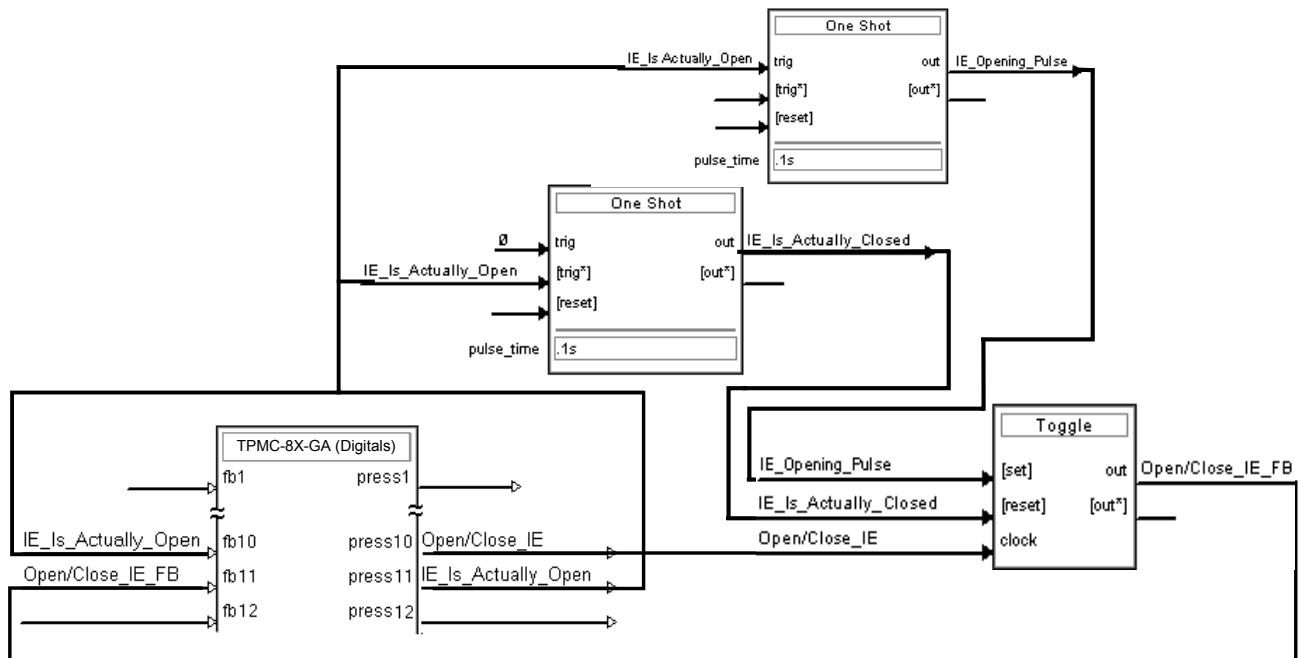

The example has Join #10 assigned to a button that is used to toggle the state of Internet Explorer. Press10 is routed to the clock line of a Toggle symbol. The output of the toggle is routed to fb11. Join #11 is referred to as the "Open/Close State Digital Join." The feedback signal of the Open/Close State Digital Join is used to Open/Close the application. In this example, when fb11 goes high, Internet Explorer opens, and when fb11 goes low, Internet Explorer closes. However, since the application can also be closed by pressing the "X" in the upper right hand corner of Internet Explorer, we must keep the logic synchronized. If we do not, the toggle will get out of sync. Similarly, using the reserved join to launch the embedded application would result in the application being open, but the state of the toggle remaining low, so a one-shot is used to set the state of the toggle if the embedded application is opened in this way.

For example, the user presses button #10 and the output of the toggle (<Open/Close IE_FB>) is high. If the user presses the "X" on IE, IE closes. The next time they touch button #10, <Open/Close IE_FB> will go low, which tries to close the application. However, the application is already closed. We need to reset the state of the toggle to keep in sync with the actual state of the application.

The "Press" signal of the Open Close State Digital Join can be used to know the true state of the application. When Press11 goes high, in this example, IE is open. When Press11 goes low, IE is closed. Here, we use the falling edge of Press11 through a One-Shot to reset the state of the Toggle symbol. Now the toggle is properly synchronized if the user closes the application from the touch screen itself.

Uploading and Upgrading

Crestron recommends using the latest programming software and that each device contains the latest firmware to take advantage of the most recently released features. However, before attempting to upload or upgrade it is necessary to establish communication.

Establishing Communication

Use Crestron Toolbox for communicating with the TPMC-8X-GA; refer to the Crestron Toolbox help file for details. There is a single method of communication: TCP/IP communication.

NOTE: Required for operation with a Crestron control system.

Ethernet Communication

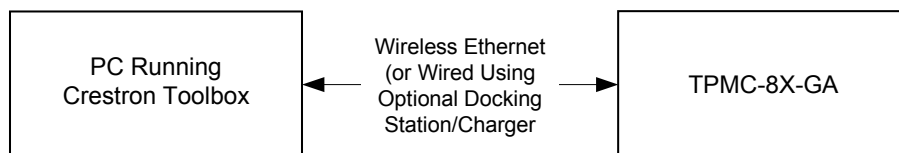

The TPMC-8X-GA connects to PC via Ethernet:

1. Enter the *IP address*, *Subnet mask* and *Default gateway* of the TPMC-8X-GA in the “Internet Protocol (TCP/IP) Properties” window (refer to “Ethernet Details” which starts on page 28).
2. Confirm Ethernet connections between TPMC-8X-GA and PC.
3. Use the Address Book in the Crestron Toolbox to create an entry for the TPMC-8X-GA with the TPMC-8X-GA’s TCP/IP communication parameters.
4. Display the “System Info” window (click the  icon) and select the TPMC-8X-GA entry.

Programs, Projects and Firmware

Program, project or firmware files may be distributed from programmers to installers or from Crestron to dealers. Firmware upgrades are available from the Crestron Web site as new features are developed after product releases. One has the option to upload programs and projects via the programming software or to upload and upgrade via the Crestron Toolbox. For details on uploading and upgrading, refer to the SIMPL Windows help file, VT Pro-e help file or the Crestron Toolbox help file.

SIMPL Windows

If a SIMPL Windows program is provided, it can be uploaded to the control system using SIMPL Windows or Crestron Toolbox.

VisionTools Pro-e

Upload the VisionTools Pro-e file to the touch screen using VisionTools Pro-e or Crestron Toolbox.

Firmware

Check the Crestron Web site to find the latest firmware. (New users may be required to register to obtain access to certain areas of the site, including the FTP site.)

Upgrade TPMC-8X-GA firmware via Crestron Toolbox.

1. Establish serial or TCP/IP communications with the TPMC-8X-GA and display the “System Info” window.
2. Select **Functions | Firmware...** to upgrade the TPMC-8X-GA firmware.

Program Checks

In Crestron Toolbox, display the “System Info window (click the  icon) and select the **Functions** menu to display actions that can be performed on the TPMC-8X-GA.

Be sure to use the Crestron Toolbox to create the TPMC-8X-GA IP table.

1. Select **Functions | IP Table Setup**.
2. Add, modify or delete entries in the IP table. The TPMC-8X-GA can have only one IP table entry.
3. A defined IP table can be saved to a file or sent to the device.

Edit the control system’s IP table to include an entry for the TPMC-8X-GA. The entry should list the TPMC-8X-GA’s IP ID (specified on the TPMC-8X-GA’s IP table) and the internal gateway IP address 127.0.0.1.

To prevent interference with other 802.11 devices that may be operating nearby, channels should be adequately spaced when configuring your wireless network; channels 1, 6 and 11 are the only non-overlapping channels. Refer to the information supplied with the WAP for instructions concerning channel selection.

Restore

The `restore` console command will restore the TPMC-8X-GA to its original factory default settings.

NOTE: The `restore` console command will not restore the original version of the firmware.

Operation

Power Options

The TPMC-8X-GA can be powered in the following ways:

- TPMC-8X-BTP Internal Battery Pack (included)
- TPMC-8X-BTPE External Battery Pack (sold separately)
- TPMC-8X-DS Desktop Docking Station/Charger (sold separately)
- TPMC-8X-DSW Wall Mount Docking Station/Charger (sold separately)

The internal and external batteries can be charged by using the included AC power pack, by connecting the TPMC-8X-GA to the optional Docking Station/Charger (TPMC-8X-DS) when it is connected to AC power or by connecting the TPMC-8X-GA to the optional Wall Mount Docking Station/Charger (TPMC-8X-DSW).

The TPMC-8X-GA has four power modes: *On*, *Standby*, *Power Down* and *Off*. Refer to the following table for details.

TPMC-8X-GA Power Modes

POWER MODE	DETAILS
On	Normal operating mode. Initiated with power button on left side of touch screen.
Standby	Backlight is turned off to conserve battery power but Wi-Fi and processor are still on and hard buttons are still functional. Initiated with <i>Standby</i> function from the setup menu.* Touch the screen to reactivate the TPMC-8X-GA from standby mode.
Power Down	Backlight is turned off, Wi-Fi is turned off and the internal processor is put into "sleep" mode to conserve battery power. Initiated with <i>Power Down</i> function from the setup menu or by momentarily pressing the power button on the left side of the touch screen.* The TPMC-8X-GA can be activated from power down mode by pressing the power button on the left side of the touch screen or by touching the screen.
Off	All power is off. Can be initiated by pressing the power button on the left side of the touch screen and holding it for four seconds. However, the recommended method for shutting down the touch screen is to press the Shut Down button on the setup menu.*

* Standby, power down and power off modes can also be initiated using reserve join numbers in VT Pro-e and the Device Extender function in SIMPL Windows. For details, refer to the respective help files in these programs.

Charging the Internal Battery

NOTE: A Lithium Ion (Li-Ion) battery typically provides 300-500 charge/discharge cycles.

There are three ways to charge the TPMC-8X-BTP Internal Battery Pack:

- With the TPMC-8X-BTP installed in the TPMC-8X-GA touch screen, connect the touch screen to an AC source using its AC adapter or
- With the TPMC-8X-BTP installed in the TPMC-8X-GA touch screen, mount the touch screen on an AC powered TPMC-8X-DS Docking Station/Charger (sold separately) or
- With the TPMC-8X-BTP installed in the TPMC-8X-GA touch screen, mount the touch screen on a TPMC-8X-DSW Wall Mount Docking Station/Charger (sold separately).

NOTE: The battery pack may take up to three hours to charge in a powered touch screen if the touch screen is in use during charging.

NOTE: When the external battery pack (TPMC-8X-BTPE, sold separately) is attached, both the internal and external battery packs charge simultaneously.

Security Infrastructure

Since the TPMC-8X-GA does not use a traditional hard drive but rather an image that gets restored every time the touch screen is rebooted, any virus infection is cleared immediately after a reboot. However, using the currently available tools and techniques, Crestron has provided an infrastructure that protects against possible virus infections.

1. Executables/Scripts brought in on external media
The implementation of the TPMC-8X-GA has restrictions on starting any application or script. The only applications that can be started are those allowed by Crestron and these can only be started from the Crestron project.
2. Downloaded Program/Script
The browser is customized in such a way that files cannot be downloaded. The only files the browser can open are the files it has plug-ins for, such as PDF, etc. The user cannot change the options, as this dialog box has been disabled.
3. Browser Hijack and Browser vulnerability
Crestron has patched all currently known hijacks and vulnerabilities. Future updates can be downloaded from the Crestron Web site.
4. Email Viruses
There is no e-mail client installed on the TPMC-8X-GA, so email-based viruses cannot be executed.
5. Viruses that attack Web/FTP servers
The TPMC-8X-GA does not run a Web or FTP server and is therefore not listening to port 21 or 80. The only ports the system listens to are the ports registered to Crestron.
6. Virus from other machines on the network
Since drives on the TPMC-8X-GA can be shared on the network, it is possible that a virus can write itself to files/folders on these shares. Our recommendation

therefore is to share as "Read-Only," so that viruses cannot attach themselves to files on the TPMC-8X-GA.

7. ActiveX and Java

The TPMC-8X-GA has ActiveX disabled and has no Java Virtual Machine installed. These applets cannot run on the TPMC-8X-GA.

NOTE: While browsing the Internet with the TPMC-8X-GA, clicking on a link may cause a message box titled "Restrictions" to appear that contains the text "This operation has been cancelled due to restrictions in effect on this computer. Please contact your system administrator." If this message appears, checking Enable Popup Windows in the "Embedded Apps" section of the setup menu may correct this error. Other restrictions may also cause this error, so this may not prevent all occurrences.

NOTE: Security settings and restrictions can be changed via the **Embed Apps** button on the setup menu. Refer to "Embed Apps (Embedded Applications)" which starts on page 20 for details.

Problem Solving

Troubleshooting

The following table provides corrective action for possible trouble situations. If further assistance is required, please contact a Crestron customer service representative.

TPMC-8X-GA Troubleshooting

TROUBLE	POSSIBLE CAUSE(S)	CORRECTIVE ACTION
Touch screen does not turn on.	Battery was not charged or is discharged.	Place the TPMC-8X-GA on the docking station and charge the battery using the provided power pack.
Cannot upload VT Pro-e project or firmware from Toolbox via Wi-Fi.	TPMC-8X-GA is off, in power down mode or has no power.	Verify that TPMC-8X-GA has power and is on or in standby mode.
	No WAPs defined/selected on the TPMC-8X-GA.	Refer to the "Ethernet Details" section of this guide, which starts on page 28 to define/select WAPs.
	No IP address configured/obtained on the TPMC-8X-GA.	Refer to "Ethernet Details" which starts on page 28 to define IP addresses. If the TPMC-8X-GA is set up to use DHCP (not recommended), you can use the WAP window box to verify the IP address provided. If the number is invalid for your subnet or no number is present, verify that the DHCP server is working properly.
	TPMC-8X-GA is out of range or has poor access to the WAPs.	The TPMC-8X-GA is out of range of the WAP or is experiencing interference. Refer to the WAP documentation for instructions on setting up a wireless network with minimum interference and no dead spots.
TPMC-8X-GA does not show feedback and/or does not control any devices.	No WAPs defined/selected on the TPMC-8X-GA	Refer to the "Ethernet Details" section of this guide, which starts on page 28 to define/select WAPs.

(Continued on following page)

TPMC-8X-GA Troubleshooting (Continued)

TROUBLE	POSSIBLE CAUSE(S)	CORRECTIVE ACTION
TPMC-8X-GA does not show feedback and/or does not control any devices. (Continued)	No IP address configured/obtained on the TPMC-8X-GA.	Refer to “Ethernet Details” which starts on page 28 to define IP addresses. If the TPMC-8X-GA is set up to use DHCP (not recommended), you can use the WAP window box to verify the IP address provided. If the number is invalid for your subnet or no number is present, verify that the DHCP server is working properly.
	Invalid control system IP address / IP ID set up on TPMC-8X-GA.	The IP address (or host name) for the control system is invalid or the IP ID does not match the one defined in the SIMPL program. Refer to “IP Table” which starts on page 33 to define IP addresses.
	TPMC-8X-GA is out of range or has poor access to the WAPs.	The TPMC-8X-GA is out of range of the WAP or is experiencing interference. Refer to the WAP documentation for instructions on setting up a wireless network with minimum interference and no dead spots.
TPMC-8X-GA shows unexpected or intermittent feedback and/or has intermittent device control.	TPMC-8X-GA is out of range or has poor access to the WAPs.	The TPMC-8X-GA is out of range of the WAP or is experiencing interference. Refer to the WAP documentation for instructions on setting up a wireless network with minimum interference and no dead spots.
TPMC-8X-GA boots up in setup screens every time.	Invalid VT Pro-e project or no VT Pro-e project is loaded.	Load/reload VT Pro-e project using the Toolbox.

Reference Documents

The latest version of all documents mentioned within the guide can be obtained from the Crestron Web site (www.crestron.com/manuals).

List of Related Reference Documents

DOCUMENT TITLE
2-Series Control Systems Reference Guide

Further Inquiries

If you cannot locate specific information or have questions after reviewing this guide, please take advantage of Crestron's award winning customer service team by calling Crestron at 1-888-CRESTRON [1-888-273-7876]. For assistance in your region, please refer to the Crestron Web site (www.crestron.com/offices) for a listing of Crestron worldwide offices.

You can also log onto the online help section of the Crestron Web site (www.crestron.com/onlinehelp) to ask questions about Crestron products. First-time users will need to establish a user account to fully benefit from all available features.

Future Updates

As Crestron improves functions, adds new features and extends the capabilities of the TPMC-8X-GA, additional information may be made available as manual updates. These updates are solely electronic and serve as intermediary supplements prior to the release of a complete technical documentation revision.

Check the Crestron Web site periodically for manual update availability and its relevance. Updates are identified as an "Addendum" in the Download column.

Appendix: TPMC-8X-GA Security Pack

In some situations, such as when your wireless access point is connected to a RADIUS (Remote Authentication Dial In User Service) server, authentication is required before network access is granted.

In order to gain access in this infrastructure, a username and password must be entered for verification by the server. To facilitate this, the TPMC-8X-GA Security Pack adds the Atheros Client configuration utility.

The Security Pack is available as a special firmware build (TPMC-8X-GA_SP_1.4.zip or later) for the TPMC-8X-GA. For details on how to upgrade firmware, refer to “Programs, Projects and Firmware” which starts on page 47.

NOTE: The TPMC-8X-GA Security Pack is only needed if authentication is required by the server with which your wireless access point communicates. If authentication is not required, Crestron recommends that you do not install this package. Once installed it cannot be removed without sending the TPMC-8X-GA back to Crestron.

To begin the authentication process for your wireless access point, touch **AP** in the “Ethernet Setup” window. (Refer to illustration on page 28.) The “Atheros Client Utility” window will open.

“Atheros Client Utility” Window

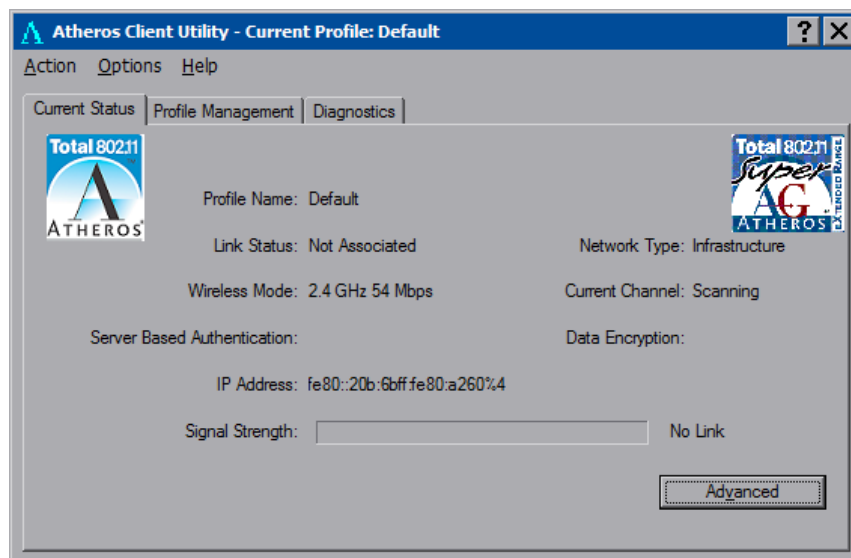

Touch the *Profile Management* tab.

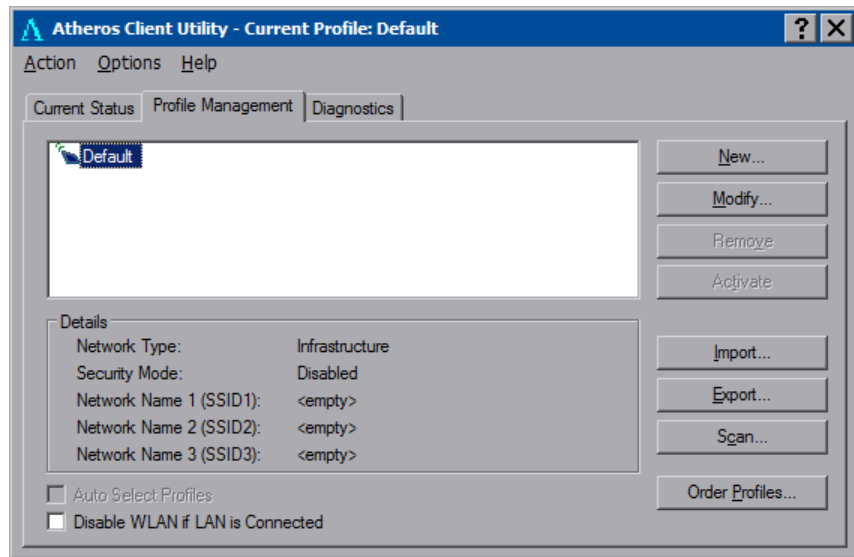
“Atheros Client Utility” Window (Profile Management Tab)

NOTE: Leave the *Disable WLAN if LAN is Connected* box unchecked.

Touch **New...** to open the “Profile Management” window.

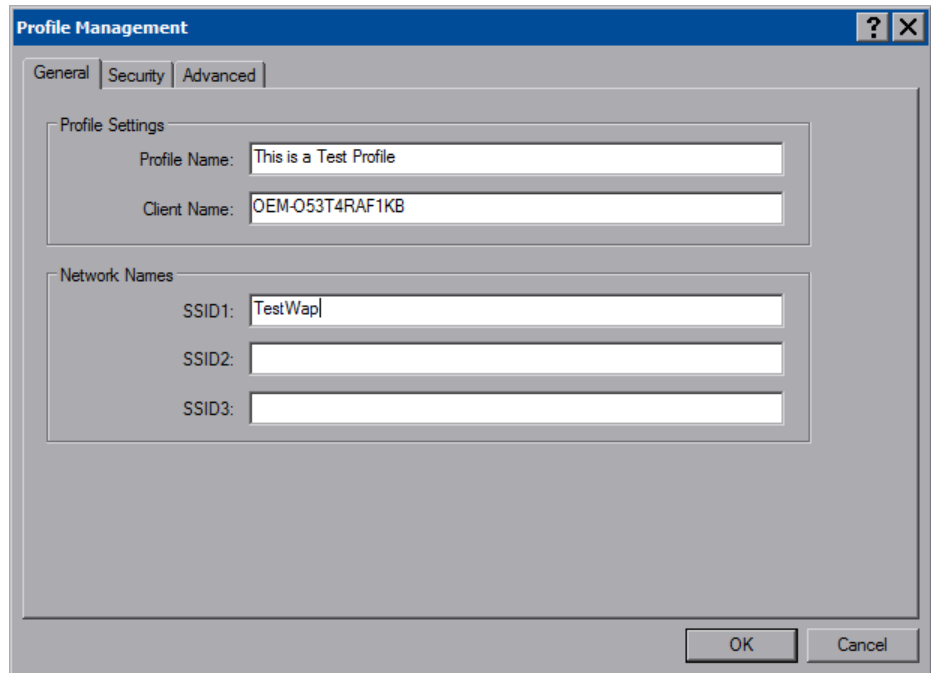
“Profile Management” Window (General)

Enter a name for the profile in *Profile Name* and the name of your wireless network in *SSID1*. Then, touch the *Security* tab.

“Profile Management” Window (Security)

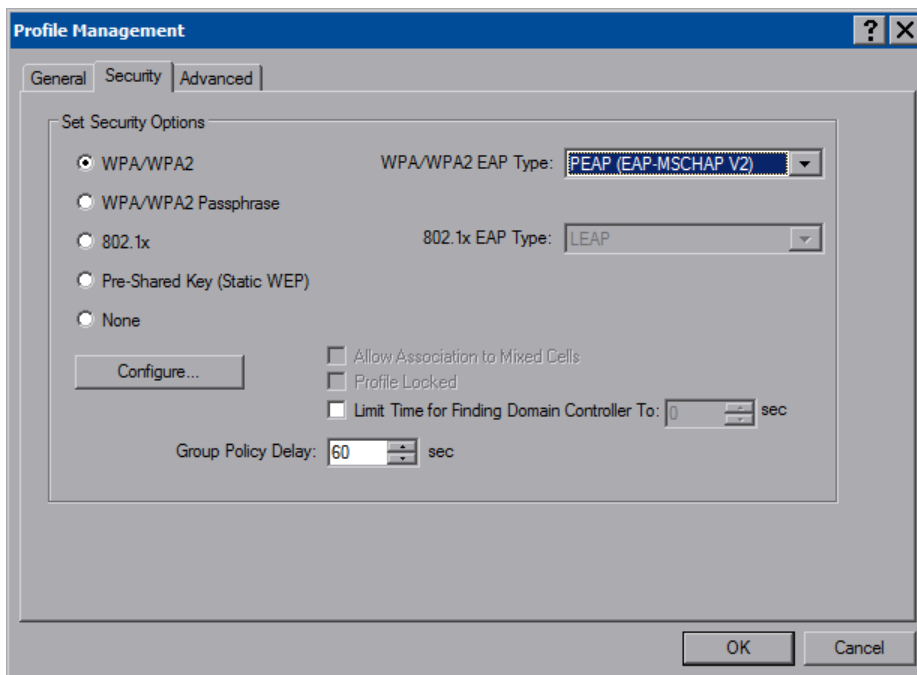

Select one of the *Security Options*. Depending on your choice, one of the drop down boxes to the right, either *WPA/WPA2 EAP Type* or *802.1x EAP Type*, will become enabled. Use the drop down box to make your selection, then touch **Configure....**

“Configure PEAP” Window

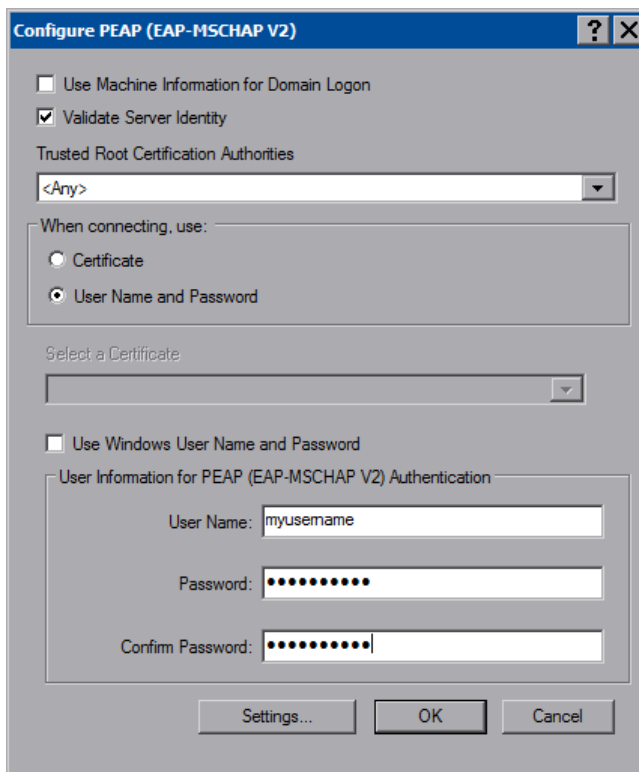

Selecting *Validate Server Identity* will enable the *Trusted Root Certification Authorities* drop down box.

Selecting *Certificate* in the *When connecting, use:* section, will enable the *Select a Certificate* drop down box.

Fill in the *User Name*, *Password* and *Confirm Password* boxes, then touch **Settings...** to open the “Configure Advanced Settings” window.

“Configure Advanced Settings” Window

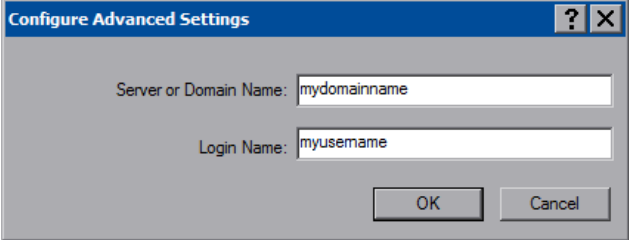

The screenshot shows a dialog box titled "Configure Advanced Settings". It has a blue title bar with a question mark icon and a close (X) icon. The main area is light gray and contains two text input fields. The first field is labeled "Server or Domain Name:" and contains the text "mydomainname". The second field is labeled "Login Name:" and contains the text "myusername". At the bottom right of the dialog are two buttons: "OK" and "Cancel".

Enter the *Server of Domain Name* and *Login Name*. Then, touch **OK**.

You will be returned to the previous window. Touch **OK** to return to the “Profile Management” window. Touch **OK** again to return to the “Atheros Client Utility” window.

With the *Profile Management* tab selected, the window will display the new entry. Select the entry within the window and touch **Activate**. To complete the process, close this window using the “X” in the upper right corner.

Return and Warranty Policies

Merchandise Returns / Repair Service

1. No merchandise may be returned for credit, exchange or service without prior authorization from Crestron. To obtain warranty service for Crestron products, contact an authorized Crestron dealer. Only authorized Crestron dealers may contact the factory and request an RMA (Return Merchandise Authorization) number. Enclose a note specifying the nature of the problem, name and phone number of contact person, RMA number and return address.
2. Products may be returned for credit, exchange or service with a Crestron Return Merchandise Authorization (RMA) number. Authorized returns must be shipped freight prepaid to Crestron, 6 Volvo Drive, Rockleigh, N.J. or its authorized subsidiaries, with RMA number clearly marked on the outside of all cartons. Shipments arriving freight collect or without an RMA number shall be subject to refusal. Crestron reserves the right in its sole and absolute discretion to charge a 15% restocking fee plus shipping costs on any products returned with an RMA.
3. Return freight charges following repair of items under warranty shall be paid by Crestron, shipping by standard ground carrier. In the event repairs are found to be non-warranty, return freight costs shall be paid by the purchaser.

Crestron Limited Warranty

Crestron Electronics, Inc. warrants its products to be free from manufacturing defects in materials and workmanship under normal use for a period of three (3) years from the date of purchase from Crestron, with the following exceptions: disk drives and any other moving or rotating mechanical parts, pan/tilt heads and power supplies are covered for a period of one (1) year; touch screen display and overlay components are covered for 90 days; batteries and incandescent lamps are not covered.

This warranty extends to products purchased directly from Crestron or an authorized Crestron dealer. Purchasers should inquire of the dealer regarding the nature and extent of the dealer's warranty, if any.

Crestron shall not be liable to honor the terms of this warranty if the product has been used in any application other than that for which it was intended or if it has been subjected to misuse, accidental damage, modification or improper installation procedures. Furthermore, this warranty does not cover any product that has had the serial number altered, defaced or removed.

This warranty shall be the sole and exclusive remedy to the original purchaser. In no event shall Crestron be liable for incidental or consequential damages of any kind (property or economic damages inclusive) arising from the sale or use of this equipment. Crestron is not liable for any claim made by a third party or made by the purchaser for a third party.

Crestron shall, at its option, repair or replace any product found defective, without charge for parts or labor. Repaired or replaced equipment and parts supplied under this warranty shall be covered only by the unexpired portion of the warranty.

Except as expressly set forth in this warranty, Crestron makes no other warranties, expressed or implied, nor authorizes any other party to offer any warranty, including any implied warranties of merchantability or fitness for a particular purpose. Any implied warranties that may be imposed by law are limited to the terms of this limited warranty. This warranty statement supersedes all previous warranties.

Crestron software, including without limitation, product development software and product operating system software is licensed to Crestron dealers and Crestron Authorized Independent Programmers (CAIPs) under a limited non-exclusive, non-transferable license pursuant to a separate end-user license agreement. The terms of this end user license agreement can be found on the Crestron Web site at www.crestron.com/legal/software_license_agreement.

Microsoft® Windows XP® Embedded End User License Agreement

- You have acquired a device (“DEVICE”) that includes software licensed by Crestron Electronics from Microsoft Licensing Inc. or its affiliates (“MS”). Those installed software products of MS origin, as well as associated media, printed materials, and “online” or electronic documentation (“SOFTWARE”), are protected by international intellectual property laws and treaties. The SOFTWARE is licensed, not sold. All rights reserved.
- IF YOU DO NOT AGREE TO THIS END USER LICENSE AGREEMENT (“EULA”), DO NOT USE THE DEVICE OR COPY THE SOFTWARE. INSTEAD, PROMPTLY CONTACT CRESTRON ELECTRONICS FOR INSTRUCTIONS ON RETURN OF THE UNUSED DEVICE(S) FOR A REFUND. **ANY USE OF THE SOFTWARE, INCLUDING BUT NOT LIMITED TO USE ON THE DEVICE, WILL CONSTITUTE YOUR AGREEMENT TO THIS EULA (OR RATIFICATION OF ANY PREVIOUS CONSENT).**
- **GRANT OF SOFTWARE LICENSE.** This EULA grants you the following license:
 - You may use the SOFTWARE only on the DEVICE.
 - **NOT FAULT TOLERANT.** THE SOFTWARE IS NOT FAULT TOLERANT. CRESTRON ELECTRONICS HAS INDEPENDENTLY DETERMINED HOW TO USE THE SOFTWARE IN THE DEVICE, AND MS HAS RELIED UPON CRESTRON ELECTRONICS TO CONDUCT SUFFICIENT TESTING TO DETERMINE THAT THE SOFTWARE IS SUITABLE FOR SUCH USE.
 - **NO WARRANTIES FOR THE SOFTWARE. THE SOFTWARE IS PROVIDED “AS IS” AND WITH ALL FAULTS. THE ENTIRE RISK AS TO SATISFACTORY QUALITY, PERFORMANCE, ACCURACY, AND EFFORT (INCLUDING LACK OF NEGLIGENCE) IS WITH YOU. ALSO, THERE IS NO WARRANTY AGAINST INTERFERENCE WITH YOUR ENJOYMENT OF THE SOFTWARE OR AGAINST INFRINGEMENT. IF YOU HAVE RECEIVED ANY WARRANTIES REGARDING THE DEVICE OR THE SOFTWARE, THOSE WARRANTIES DO NOT ORIGINATE FROM, AND ARE NOT BINDING ON, MS.**
 - **No Liability for Certain Damages. EXCEPT AS PROHIBITED BY LAW, MS SHALL HAVE NO LIABILITY FOR ANY INDIRECT, SPECIAL, CONSEQUENTIAL OR INCIDENTAL DAMAGES ARISING FROM OR IN CONNECTION WITH THE USE OR PERFORMANCE OF THE SOFTWARE. THIS LIMITATION SHALL APPLY EVEN IF ANY REMEDY FAILS OF ITS ESSENTIAL PURPOSE. IN NO EVEN SHALL MS BE LIABLE FOR ANY AMOUNT IN EXCESS OF U.S. TWO HUNDRED FIFTY DOLLARS (U.S. \$250.00).**
 - **Limitations on Reverse Engineering, Decompilation, and Disassembly.** You may not reverse engineer, decompile, or disassemble the SOFTWARE, except and only to the extent that such activity is expressly permitted by applicable law notwithstanding this limitation.
 - **SOFTWARE TRANSFER ALLOWED BUT WITH RESTRICTIONS.** You may permanently transfer rights under this EULA only as part of a permanent sale or transfer of the Device, and only if the recipient agrees to this EULA. If the SOFTWARE is an upgrade, any transfer must also include all prior versions of the SOFTWARE.
 - **EXPORT RESTRICTIONS.** You acknowledge that SOFTWARE is subject to U.S. export jurisdiction. You agree to comply with all applicable international and national laws that apply to the SOFTWARE, including the U.S. Export Administration Regulations, as well as end-user, end-use and destination restrictions issued by U.S. and other governments. For additional information, see www.microsoft.com/exporting.
- **Limited Use of Particular SOFTWARE Services.** Provided that the DEVICE continues to comply with the terms of the “Restricted Functionality” paragraph below, without limiting the number of computers or other electronic devices that might connect to the DEVICE to access or utilize other software or SOFTWARE services on the DEVICE, you may permit a maximum of ten (10) computers or other electronic devices to connect to the DEVICE to utilize the services of the SOFTWARE for (a) file and print services, (b) Internet information services, and/or (c) remote access (including connection sharing). The ten (10) connections maximum includes any indirect connections made through “multiplexing” or other software or hardware which pools or aggregates connections.
- If you use the DEVICE to access or utilize the services or functionality of Microsoft Windows Server products (such as Microsoft Windows NT Server 4.0 (all editions) or Microsoft Windows 2000 Server (all editions)), or use the DEVICE to permit workstation or computing devices to access or utilize the services or functionality of Microsoft Windows Server products, you may be required to obtain a Client Access License for the DEVICE and/or each such workstation or computing device. Please refer to the End-User License Agreement for your Microsoft Windows Server product for additional information.
- **Restricted Deployment.** The SOFTWARE is not designed or intended for use or resale in hazardous environments requiring fail-safe performance, such as in the operation of nuclear facilities, aircraft navigation or communication systems, air traffic control, or other devices or systems in which a malfunction of the SOFTWARE would result in foreseeable risk of injury or death to the operator of the device or system, or to others.
- **Restricted Functionality.** You are licensed to use the SOFTWARE to provide only the limited functionality (specific tasks or processes) for which the DEVICE has been designed and marketed by Crestron. This license specifically prohibits any other use of the SOFTWARE, or inclusion of additional software programs or functions, on the DEVICE. Subject to the terms of the “Limited Use of Particular Services” paragraph above, you may use the SOFTWARE on the DEVICE to interact with other computers or electronic devices.

- **Maximum Number of Processors.** The SOFTWARE may not be used by more than two (2) processors at any one time on the DEVICE.
- **Remote Boot Feature.** Your DEVICE may be enabled with a Remote Boot feature which includes Remote Boot Installation Services tool. You may use the Remote Boot Installation Services tool only to deploy the SOFTWARE to one or more DEVICES on which you are licensed to run the SOFTWARE (i.e., DEVICES to which the appropriate Certificate of Authenticity is affixed). Please refer to the DEVICE documentation, if provided with your DEVICE, or contact Crestron for additional information.
- **Security Updates.** Content providers are using the digital rights management technology (“Microsoft DRM”) contained in this SOFTWARE to protect the integrity of their content (“Secure Content”) so that their intellectual property, including copyright, in such content is not misappropriated. Owners of such Secure Content (“Secure Content Owners”) may, from time to time, request MS, Microsoft Corporation, or their subsidiaries to provide security related updates to the Microsoft DRM components of the SOFTWARE (“Security Updates”) that may affect your ability to copy, display, and/or play Secure Content through Microsoft software or third-party applications that utilize Microsoft DRM. You therefore agree that, if you elect to download a license from the Internet, which enables our use of Secure Content, MS, Microsoft Corporation, or their subsidiaries may, in conjunction with such license, also download onto your DEVICE such Security Updates that a Secure Content Owner has requested that MS, Microsoft Corporation, or their subsidiaries distribute. MS, Microsoft Corporation, or their subsidiaries will not retrieve any personally identifiable information, or any other information, from your DEVICE by downloading such Security Updates.
- **NetMeeting[®]/Remote Assistance/Remote Desktop Features.** The SOFTWARE may contain NetMeeting, Remote Assistance, and Remote Desktop technologies that enable the SOFTWARE or other applications installed on the Device to be used remotely between two or more computing devices, even if the SOFTWARE or application is installed on only one Device. You may use NetMeeting, Remote Assistance, and Remote Desktop with all Microsoft products; provided, however, use of these technologies with certain Microsoft products may require an additional license. For both Microsoft products and non-Microsoft products, you should consult the license agreement accompanying the applicable product or contact the applicable licensor to determine whether use of NetMeeting, Remote Assistance, or Remote Desktop is permitted without an additional license.
- **Consent to Use of Data.** You agree that MS, Microsoft Corporation, and their affiliates may collect and use technical information gathered in any manner as part of product support services related to the SOFTWARE. MS, Microsoft Corporation, and their affiliates may use this information solely to improve their products or to provide customized services or technologies to you. MS, Microsoft Corporation, and their affiliates may disclose this information to others, but not in a form that personally identifies you.
- **Internet Gaming/Update Features.** If the SOFTWARE provides, and you choose to utilize, the Internet gaming or update features within the SOFTWARE, it is necessary to use certain computer system, hardware, and software information to implement the features. By using these features, you explicitly authorize MS, Microsoft Corporation, and/or their designated agent to use this information solely to improve their products or to provide customized services or technologies to you. MS or Microsoft Corporation may disclose this information to others, but not in a form that personally identifies you.
- **Internet –Based Services Components.** The SOFTWARE may contain components that enable and facilitate the use of certain Internet-based services. You acknowledge and agree that MS, Microsoft Corporation, or their affiliates may automatically check the version of the SOFTWARE and/or its components that you are utilizing and may provide upgrades or supplements to the SOFTWARE that may be automatically downloaded to your Device.
- **Links to Third-Party Sites.** The SOFTWARE may provide you with the ability to link to third-party sites through the use of the SOFTWARE. The third-party sites are not under the control of MS, Microsoft Corporation, or their affiliates. Neither MS nor Microsoft Corporation nor their affiliates are responsible for (i) the contents of any third-party sites, any links contained in third-party sites, or any changes or updates to third-party sites, or (ii) webcasting or any other form of transmission received from any third-party sites. If the SOFTWARE provides links to third-party sites, those links are provided to you only as a convenience, and the inclusion of any link does not imply an endorsement of the third-party site by MS, Microsoft Corporation, or their affiliates.
- **Additional Software/Services.** The SOFTWARE may permit Crestron, MS, Microsoft Corporation, or their affiliates to provide or make available to you SOFTWARE updates, supplements, add-on components, or Internet-based services components of the SOFTWARE after the date you obtain your initial copy of the SOFTWARE (“Supplemental Components”).
 - If Crestron provides or makes available to you Supplemental Components and no other EULA terms are provided along with the Supplemental Components, then the terms of this EULA shall apply.
 - If MS, Microsoft Corporation, or their affiliates make available Supplemental Components, and no other EULA terms are provided, then the terms of this EULA shall apply, except that the MS, Microsoft Corporation, or affiliate entity providing the Supplemental Component(s) shall be the licensor of the Supplemental Component(s).

Crestron, MS, Microsoft Corporation, and their affiliates reserve the right to discontinue any Internet-based services provided to you or made available to you through the use of the SOFTWARE.

This EULA does not grant you any rights to use the Windows Media Format Software Development Kit (“WMFSDK”) components contained in the SOFTWARE to develop a software application that uses Windows Media technology. If you wish to use the WMFSDK to develop such an application, visit <http://msdn.Microsoft.com/workshop/imedia/windowsmedia/sdk/wmsdk.asp>, accept a separate license for the WMFSDK, download the appropriate WMFSDK, and install it on your system.



Crestron Electronics, Inc.
15 Volvo Drive Rockleigh, NJ 07647
Tel: 888.CRESTRON
Fax: 201.767.7576
www.crestron.com

Operations Guide – DOC. 7078D
(2028795)
12.11
Specifications subject to
change without notice.